

SPECIFICATION**FOR****M/N: MPM-K453(-SB)(-1/2/C/F)****450W MEDICAL POWER SUPPLY WITH****SAFETY CLASS II AND OPTIONAL INSTALLATION KITS****Revision History**

Version	Date	Change Items
Rev. 01	Sep. 09.2019	Established.
Rev. 02	Feb. 26.2020	1.Added ripple & noise "Maximum 100(V ²)". 2.Changed EMI diagram.
Rev. 03	Oct. 05.2020	1.Added Peak Load 600W depiction. 2.Changed Mechanical diagram.
Rev. 04	Dec. 04.2020	Added 62368-1 safety.
Rev. 05	Apr. 01.2021	Added note for PG signal & 5VSB OVP.
Rev. 06	May. 27. 2022	Changed "IP to Ground" and "OP to Ground" to 1800VAC.

MPM-K453(-SB)(-1/2/C/F)

450W Medical AC / DC

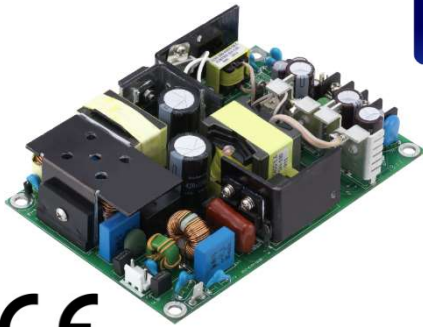

FEATURES

- ✓ 300W convection cooling and 450W fan cooling.
- ✓ Peak Load 600W.
- ✓ Safety Class I or Class II.
- ✓ Design for BF application.
- ✓ High efficiency up to 94%.
- ✓ No load input power < 0.5W.
- ✓ Built-in fan supply.
- ✓ Medical Safety IEC/UL 60601-1 3.1 approved. Also designed to meet IT Standard IEC 62368-1.
- ✓ Optional remote on/off and PG / PF signal.
- ✓ 5,000m operation altitude.
- ✓ Optional cover-kit.

Models & Ratings

Model Number	Wattage (Rated / Max)	Output Voltage		Min. Current	Rated Current	Max. Current
MPM-K453	300 W / 400~450 W	V1	+12 V	0 A	25 A	37.5 A
MPM-K453-SB	300 W / 400~450 W	V1	+12 V	0 A	25 A	37.5 A
		V2	+5 V	0 A	0.5 A	1 A
MPM-K453(-SB)-F		V Fan	+12 V		0.25 A	

Total Output Power: Max. 300W convection cooled at 50°C environment temperature. Max. 450W with 16.3 CFM at 50°C environment temperature. 600W peak load with input 100VAC 10sec (Note 3).

Note:

1. Please refer to page 3 output for the detail notes & conditions.
2. Initial Setting Accuracy is at Input 115VAC and all output at 60% rated load.
3. Peak load derating curve:
 600W peak load with input 100VAC-264VAC 10sec
 500W peak load with input 90VAC 10sec
 460W peak load with input 85VAC 10sec
4. No load 0.5W only with 5VSB.

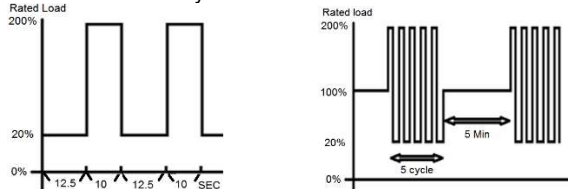

5. Model no. coding:

MPM-K453-X-Y

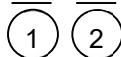

1	X=	Output set
	blank	Single output
	SB	Dual output (with +5Vsb & remote on/off & PG/PF function)

Y=	Cover Type
1	No cover, open frame CLASS I
2	Additional bottom plate CLASS II
F	With cover and internal fan CLASS I, II
C	With cover only CLASS I, II

Summary

Characteristic	Minimum	Typical	Maximum	Units	Notes & Conditions
Input Range	85	115 / 230	264	Vac	Universal input range.
Input Frequency	47	50 / 60	63	HZ	
Efficiency		94		%	At input 230Vac, rated load, 1.0 hr. warm up.
Operation Temperature	-30		+70	°C	
Weight		520		g	MPM-K453-SB-1
Dimensions	152.4 (L) x 101.6 (W) x 37.6/40.1 (H) mm, Tolerance +/- 0.5mm.				
EMC	EN 55011, EN 60601-1-2, EN 61000-3-2, EN 61000-3-3, IEC 61000-4-2, IEC 61000-4-3, IEC 61000-4-4, IEC 61000-4-5, IEC 61000-4-6, IEC 61000-4-8, IEC 61000-4-11				
Safety Approvals	EN 60601-1: 2006+A11+A1+A12, IEC 60601-1: 2005+CORR. 1: 2006+CORR. 2: 2007+A1: 2012, ANSI/AAMI ES60601-1, CAN/CSA-C22. 2 No. 60601-1, EN 60601-1: 2006+A11+A1+A12 approved. *IEC 62368-1 designed to meet.				

MPM-K453(-SB)(-1/2/C/F) 450W Medical AC / DC

Input

Characteristic	Minimum	Typical	Maximum	Units	Notes & Conditions
Input Voltage - Operating	85	115 / 230	264	Vac	Universal input range.
Input Voltage – Fault Condition			280	Vac	5 seconds max.
Input Frequency	47	50 / 60	63	HZ	AC input.
Power Factor		0.95 / 0.90			115Vac/230Vac at rated load.
Input Current		6.3 / 2.5		A	Nominal AC Input Voltage (115Vac/230Vac), rated load.
Inrush Current			30 / 60	A	Nominal AC Input Voltage (115Vac/230Vac), one cycle at 25°C cold start.
Standby Input Power			0.5	W	at 230Vac.
Input Protection	Dual non-user serviceable internally located AC input line fuse. Fuse : T6.3A / 250Vac * 2pcs				

Output

Characteristic	Minimum	Typical	Maximum	Units	Notes & Conditions
Output Voltage		12 ^(V1)		Vdc	Only for –SB version.
		5 ^(V2)			
	11	12 ^(V Fan)	13		
Output Current		25 ^(V1)	37.5	A	Only for –SB version.
		0.5 ^(V2)	1		
		0.25 ^(V Fan)			
Initial Set Accuracy (Note 1)		±1		%	
Minimum Load		0		A	
Start Up Delay		1		Sec.	Time required for initial output voltage stabilization. Nominal AC Input Voltage (115VAC/230VAC), rated load at 25°C.
Hold Up Time		25(300w)		mS	Nominal AC Input Voltage (115VAC/230VAC), rated load.
		16(450w)		mS	Nominal AC Input Voltage (115VAC/230VAC), max load.
Line Regulation		±1		%	Measured at rated load with ±10% changing in input voltage.
Load Regulation		±1		%	Measured from 60% to 100% rated load and from 60% to 20% rated load (60% ±40% rated load).
Ripple & Noise (Note 2)		120 ^(V1) 50 ^(V2)	100 ^(V2)	mV	Rated load, 20MHz bandwidth.
Over Voltage Protection	110	120	140	%	Latch-off mode.
Short Protection		Short Circuit		%	Auto-recovery mode.
Remote On/Off		Complies			Only for –SB version.
Peak Load 600W		10		Sec.	It has a time limit for Peak 600W, when exceeding the duration (10 Seconds) the latch off function will be activated.

Note:

1. Initial setting accuracy is adjusted at input 115VAC and output at 60% rated load.
2. Measured by a 20MHz bandwidth limited oscilloscope and each output is connected with a 10µF Electrolytic Capacitor and a 0.1µF Ceramic Capacitor.
3. 5VSB OVP 7.9V Max & Auto recovery mode.

General

Characteristic	Minimum	Typical	Maximum	Units	Notes & Conditions
Efficiency		94		%	At input 230VAC, rated load, 1 hr. warm up.
Isolation	IP to OP	4000		Vac	2 MOPP
	IP to Ground	1800		Vac	1 MOPP
	OP to Ground	1800		Vac	1 MOPP
Earth Leakage Current			300	μA	264Vac/60HZ
Patient Leakage Current			100	μA	264Vac/60HZ
Switching Frequency		67		KHZ	
MTBF		183006		hrs.	MIL-HDBK-217F at 25°C
Power Good Signal	100		500	mS	When power is turned on, the power good signal will go high after the output voltage are within regulation limit. Only for -SB model.
Power Fail Signal	1			mS	When power is turned off, the power fail signal will go low before the output voltage fall below the regulation limit. Only for -SB model.

Note:

1. Load dynamic must meet the following range in order to maintain PG signal.

600W: 10%-100%; 450W: 6%-100%; 300W: 0.2%-100%

Environmental

Characteristic	Minimum	Typical	Maximum	Units	Notes & Conditions
Low temperature start up	-30			°C	Some specification parameters maybe exceeded until after 20 minutes warm up period. (Note 1)
Operating Temperature	-30		+70	°C	Derate linearly above 50°C, performance curves will be provided after testing.
Storage Temperature	-40		+85	°C	
Relative Humidity	5		95	%RH	Non-condensing.
Cooling		16.3		CFM	Forced-cooled > 300W
Operating Altitude		5000		m	
Vibration		0.26		G	Frequency Type: Sweep Frequency Frequency Range: 10~55 Hz Displacement: 1.0mm Sweep Rate: 60 minute / cycle Number of cycle: 1 cycle / axis Direction: X, Y and Z axis

Note:

1. To start up at low temperature, when the $V_{IP} < 100VAC$, please set the rated load @ 80% for maximum; when $V_{IP} \geq 100VAC$, there will be no specific limitation on rated load setting.

MPM-K453(-SB)(-1/2/C/F) 450W Medical AC / DC

EMC: Emissions

Phenomenon	Standard	Class	Notes & Conditions
Conducted	EN 55011 / CISPR 11 & FCC Part 18	B	1. Measured without enclosure. 2. Measured with a metal plate below the power supply. 3. Class II Primary need to add EMI Core around four turns, secondary need EMI Core through the output wire (EROCORE A81280200160). 4. Class II Pass EMI with build in metal plate below the power supply. 5. Class I Pass EMI with a metal plate below the power supply and Load.
Radiated	EN 55011 / CISPR 11 & FCC Part 18	B	
Harmonic Current	EN 61000-3-2	D	
Voltage Flicker	EN 61000-3-3		

- Note:
- Above specification is applied with output equal or below 300W (Class II). For higher output power, please re-confirm with us.
 - Above specification is applied with output equal or below 450W (Class I).
 - Above specification is based on the test conditions of EN 55011 / CISPR 11 & FCC Part 18. If there is any question when the power supply is applied to the system, please contact us for assistance.

EMC: Immunity

Phenomenon	Standard	Criteria	Notes & Conditions
Medical Device EMC	IEC 60601-1-2: 2014	As below	Edition 4.0
ESD	IEC 61000-4-2	A	±15KV air discharge, ±8KV contact discharge
Radiated	IEC 61000-4-3	A	10V/m
EFT	IEC 61000-4-4	A	±2KV Line & PE at 100KHz
Surges	IEC 61000-4-5	A	L-N:±1KV, L/N-PE:±2KV
Conducted	IEC 61000-4-6	A	10V
Power Magnetic	IEC 61000-4-8	A	30A/m
Dips and Interruptions	IEC 61000-4-11	A A A/B B	DIP: 100%, 0.5 cycles DIP: 100%, 1 cycles Note3 DIP: 30%, 25 cycle Note2 DIP: 100%,5 Sec

- Note:
- Above specification is applied with output equal or below 450W. For higher output power, please re-confirm with us.
 - The test result of input 240Vac / 100Vac is criteria A / B.
 - The test result of output 300W / 450W is criteria A / B.

Safety Approvals

Safety Agency	Safety Standard	Notes & Conditions
CB	IEC 60601-1: 2005+CORR. 1: 2006+CORR. 2: 2007+A1: 2012	Approved (Medical 3.1 rd).
UL/cUL	ANSI/AAMI ES60601-1, CAN/CSA-C22. 2 No. 60601-1	Approved (Medical 3.1 rd).
IEC/EN	62368-1:2014	Designed to meet.

- Note:
- If you want to use a metal plate under this power, the distance in between accessible metal part needs to add at least 4mm of 1xMOPP to meet Class II.

Derating curve

MPM-K453-SB-1 and MPM-K453-1
MPM-K453-SB-2 and MPM-K453-2

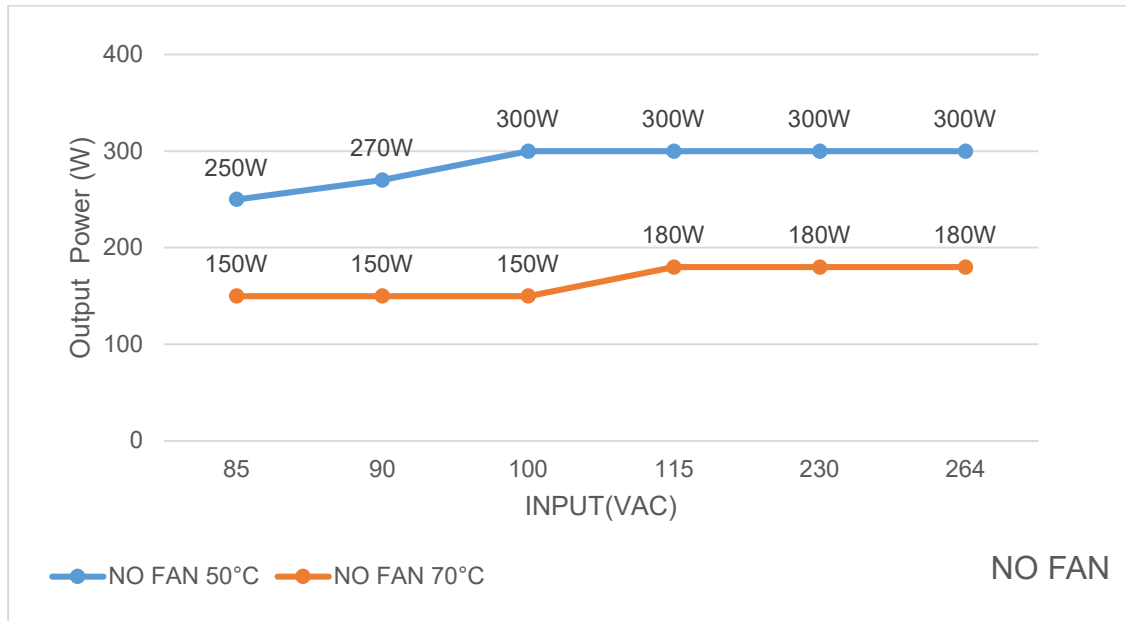

5VSB Load 50°C1A,70°C0.5A

MPM-K453-SB-F and MPM-K453-F

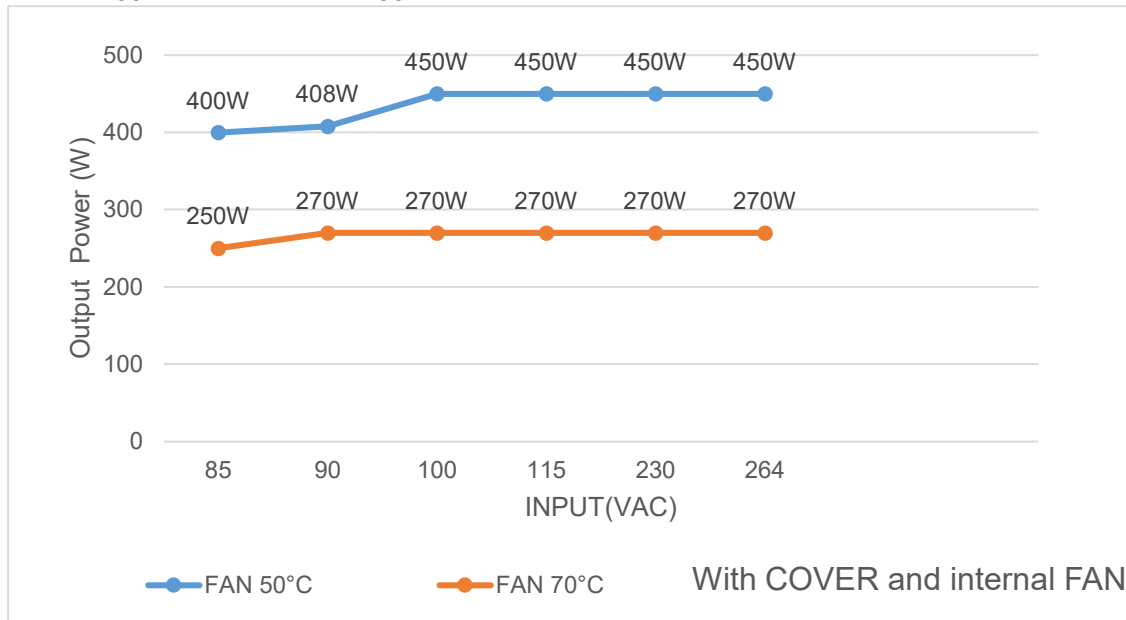

Test with Fan 40mm/ AIR FLOW :10.8CFM
5VSB Load 50°C1A,70°C0.5A

MPM-K453-SB-C and MPM-K453-C

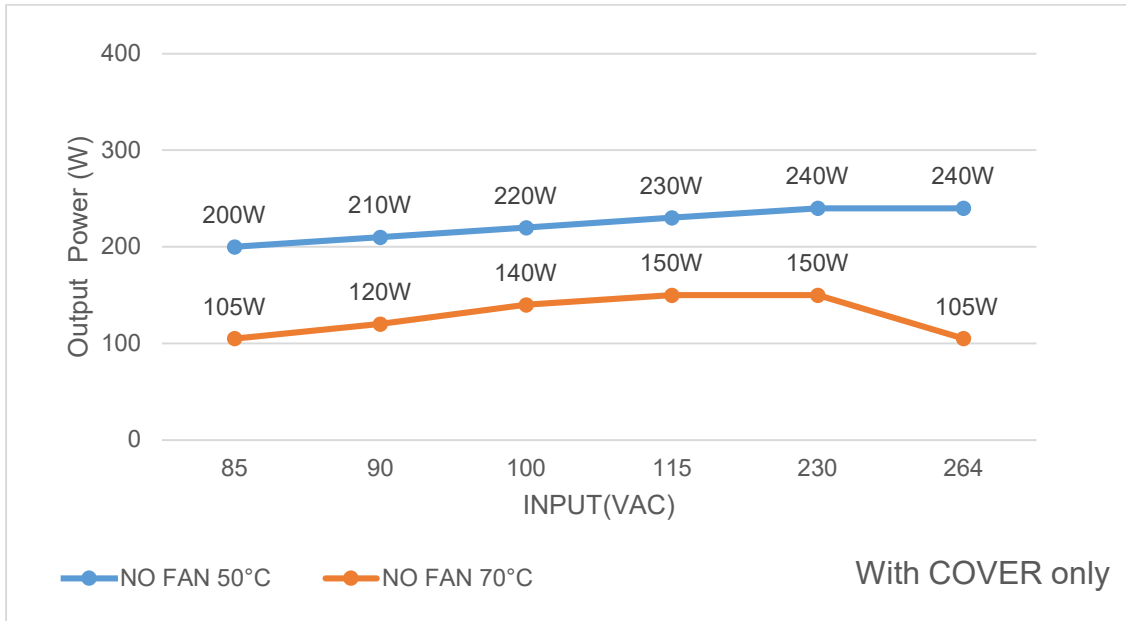

5VSB Load 50°C1A,70°C0.5A

MPM-K453-SB-1 and MPM-K453-1 (Fan provided by customer)
MPM-K453-SB-2 and MPM-K453-2

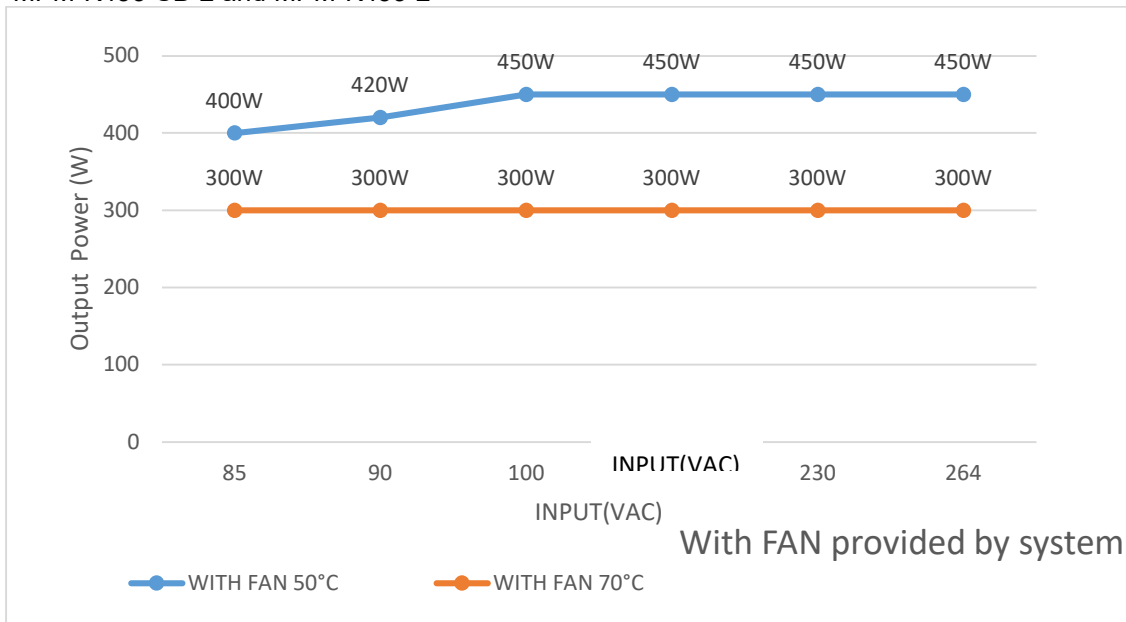

5VSB Load 50°C1A,70°C0.5A
Test with Fan 60mm/ AIR FLOW :16.3CFM

MPM-K453(-SB)(-1/2/C/F)

450W Medical AC / DC

Mechanical Details

(MPM-K453-SB-1 & MPM-K453-1)

All dimensions are in Inches [mm] Tolerance ± 0.02 [± 0.5]

CLASS I

Ac Input Connector CN1
 Metes with MOLEX
 09-50-1031(5195-03) OR 09-52-4034(5239-03)
 OR Equivalent
 JST: VHR-3N OR Equivalent (Note)

PIN number	PIN assignment
1	AC in(L)
2	AC in(N)

Note:Exist with model no.suffixed -J,
 please see comparison in Model no.coding:

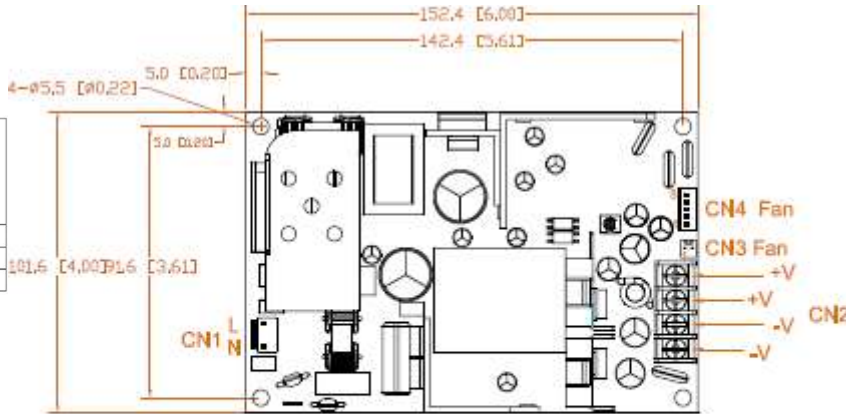

Singal Connector CN4
 MOLEX5045-05A or Equivalent

PIN number	PIN assignment
1	Fan 12V (V Fan)
2	0V
3	+5VSB(Vz)
4	PG/PF
5	Remote

NOTE: Pin 3 & Pin5 don't have
 function in Non -SB models.

Singal Connector CN3
 MOLEX5045-02A or Equivalent

PIN number	PIN assignment
1	Fan 12V (V Fan)
2	0V

Dc Output Terminal Blocks CN2
 DINKLE DT-35
 European type by request

PIN number	PIN assignment
1	+V
2	+V
3	-V
4	-V

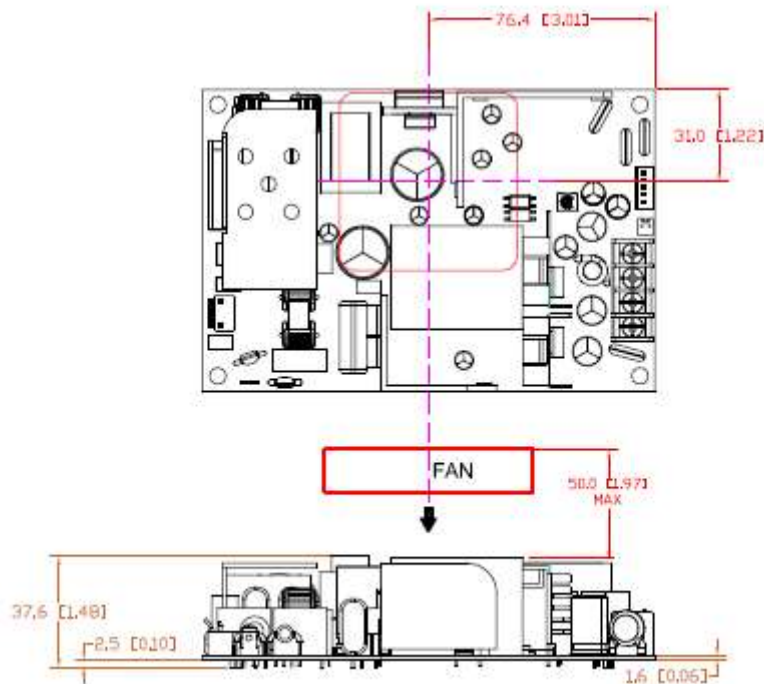

Note:
 If you want to use the metal plate beneath this PSU as class II, the metal plate should be treated as "floating" that both distances from human body and primary side to accessible metal part (plate) have to be at least 4mm of 1xMOPP to meet Class II (The metal plate should be kept 1XMOPP away from human body).

MPM-K453(-SB)(-1/2/C/F) 450W Medical AC / DC

(MPM-K453-SB-2 & MPM-K453-2)

All dimensions are in Inches [mm] Tolerance ± 0.02 [± 0.5]

CLASS II

Ac Input Connector CN1
Mates with MOLEX
09-50-1031(5195-03) OR 09-52-4034(5239-03)
OR Equivalent
JST: VHR-3N OR Equivalent (Note)

PIN number	PIN assignment
1	AC in(L)
2	AC in(N)

Note: Exist with model no. suffixed -J,
please see comparison in Model no. coding:

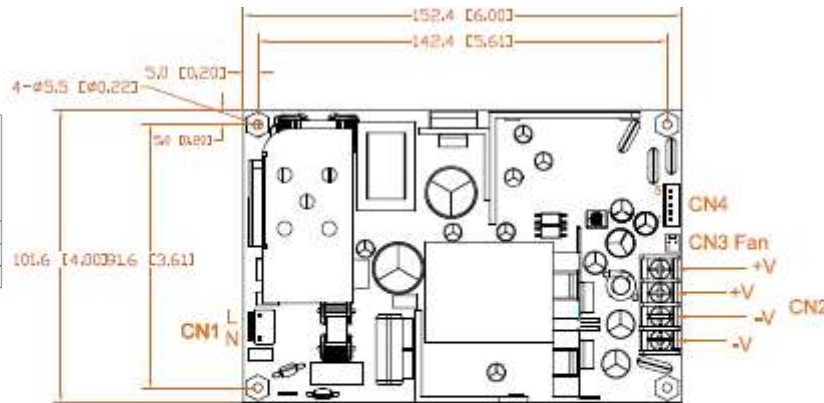

Single Connector CN4
MOLEX5045-05A or Equivalent

PIN number	PIN assignment
1	Fan 12V (V _{Fan})
2	0V
3	+5VSB(V ₂)
4	PG/PF
5	Remote

NOTE: Pin 3 & Pin5 don't have function in Non -SB models.

Single Connector CN3
MOLEX5045-02A or Equivalent

PIN number	PIN assignment
1	Fan 12V (V _{Fan})
2	0V

Dc Output Terminal Blocks CN2
DINKLE DT-35
European type by request

PIN number	PIN assignment
1	+V
2	+V
3	-V
4	-V

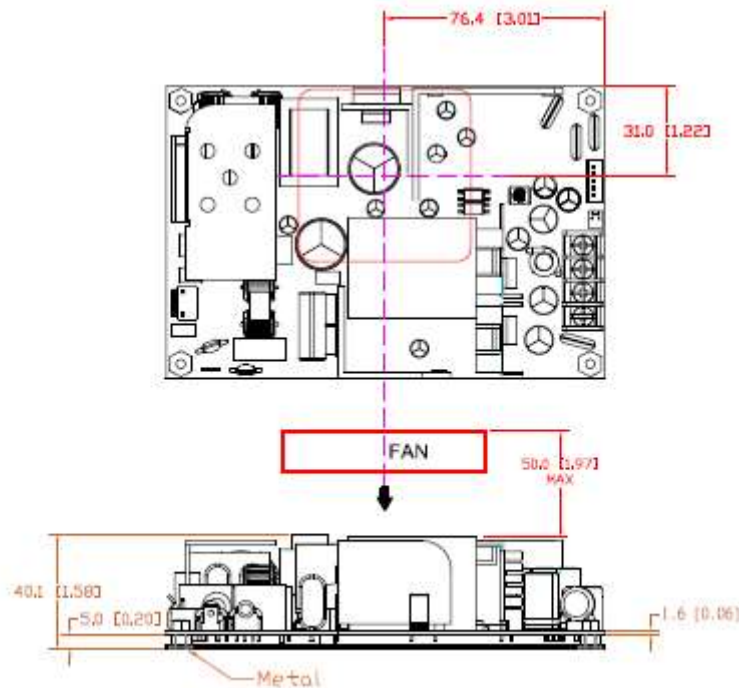

Application notes :

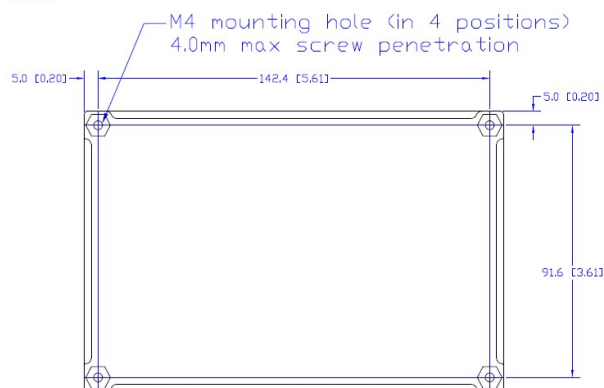
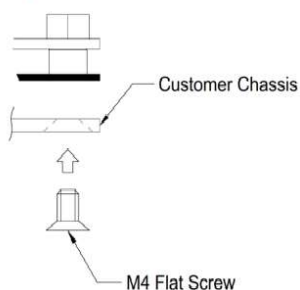

Note:
The safety GND should be connected to the customer's enclosure.

MPM-K453(-SB)(-1/2/C/F)

450W Medical AC / DC

(MPM-K453-SB-C & MPM-K453-C)

All dimensions are in Inches [mm] Tolerance: +/- 0.5mm

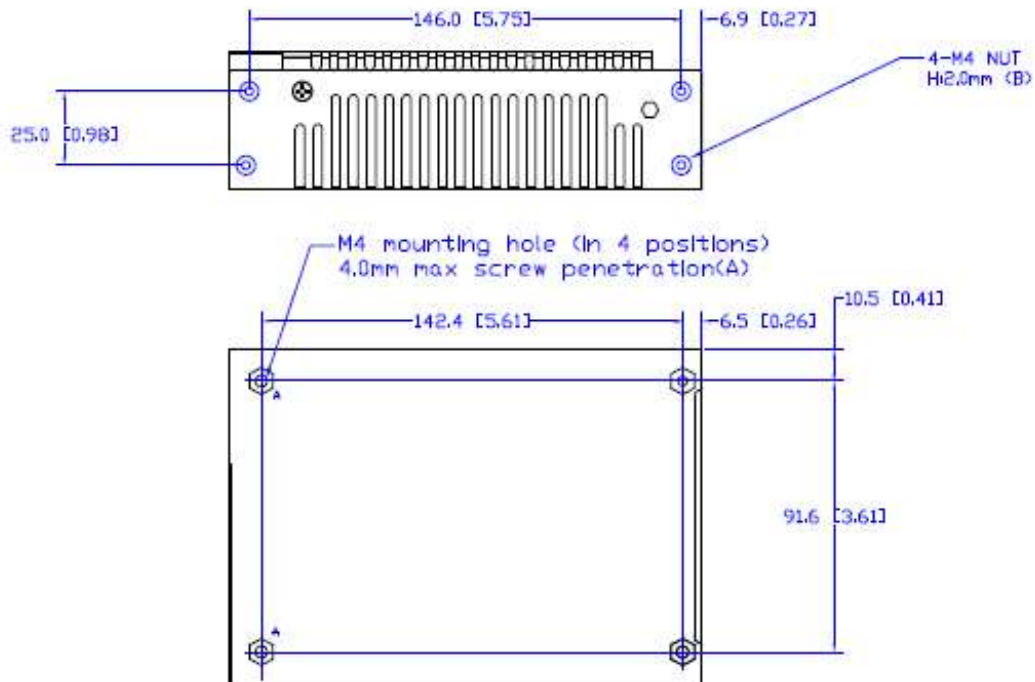
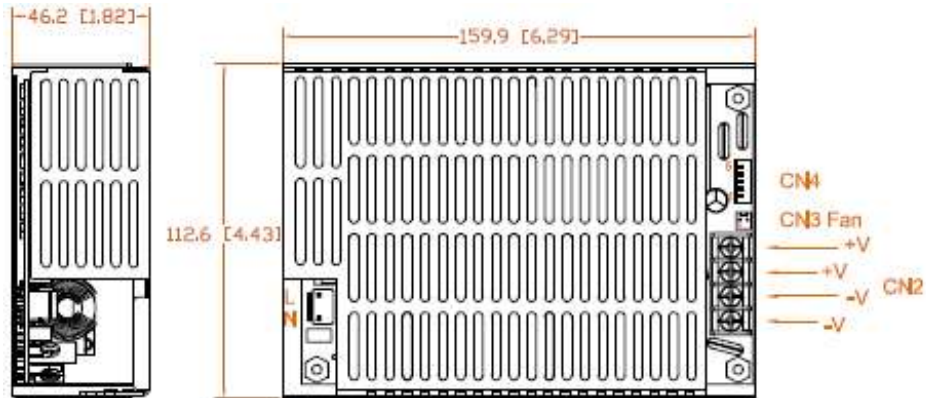

Note:
If you want to use the metal plate beneath this PSU as class II, the metal plate should be treated as "floating" that both distances from human body and primary side to accessible metal part (plate) have to be at least 4mm of 1xMOPP to meet Class II (The metal plate should be kept 1XMOPP away from human body).

MPM-K453(-SB)(-1/2/C/F)

450W Medical AC / DC

(MPM-K453-SB-F & MPM-K453-F)

All dimensions are in Inches [mm] Tolerance: +/- 0.5mm

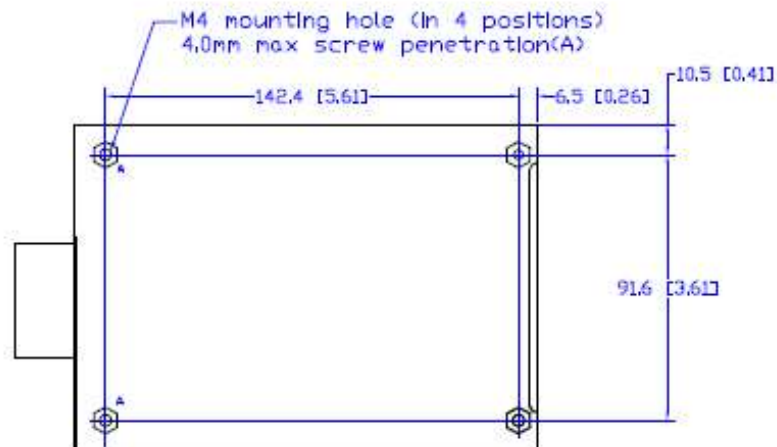
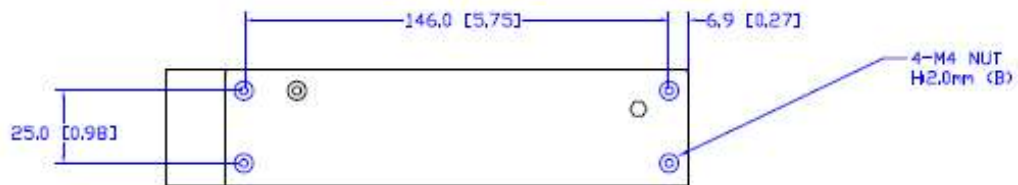
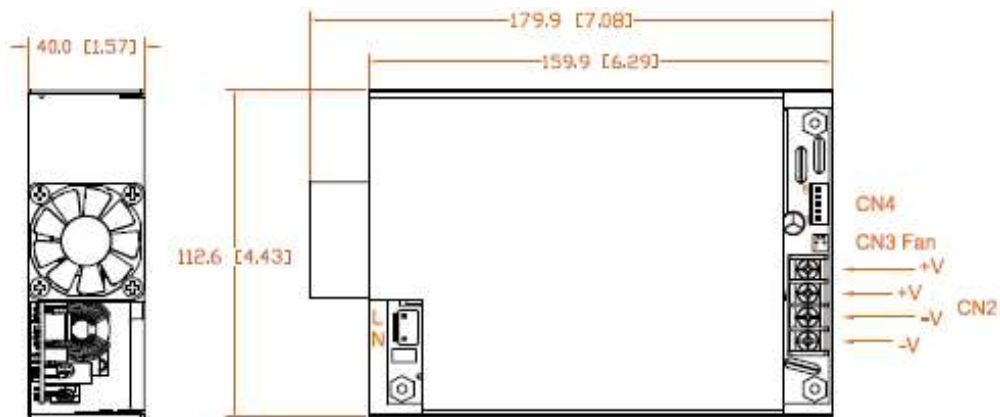

Note:

If you want to use the metal plate beneath this PSU as class II, the metal plate should be treated as "floating" that both distances from human body and primary side to accessible metal part (plate) have to be at least 4mm of 1xMOPP to meet Class II (The metal plate should be kept 1XMOPP away from human body).

MPM-K453(-SB)(-1/2/C/F) 450W Medical AC / DC

Performance

(Input voltage: 115Vac)

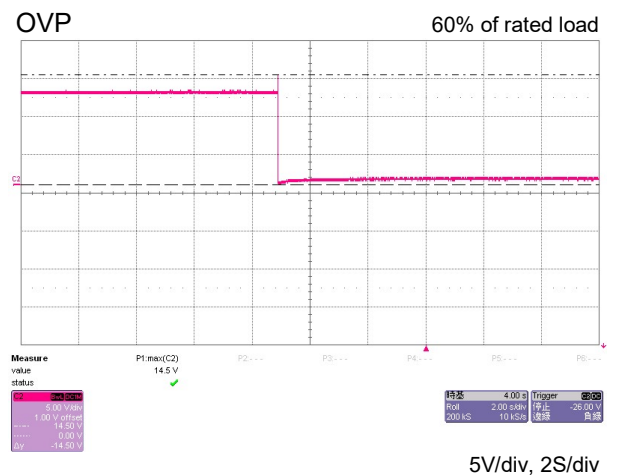
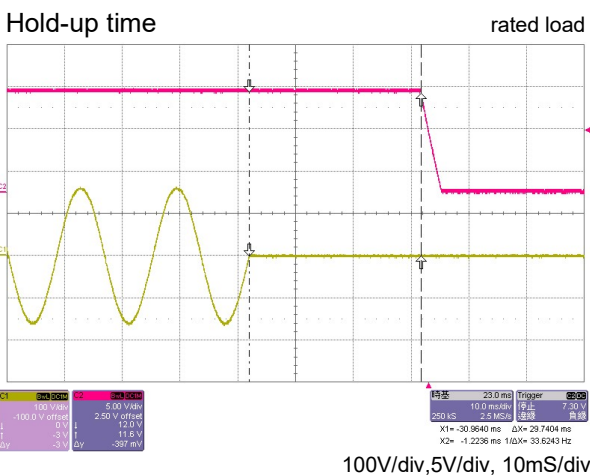
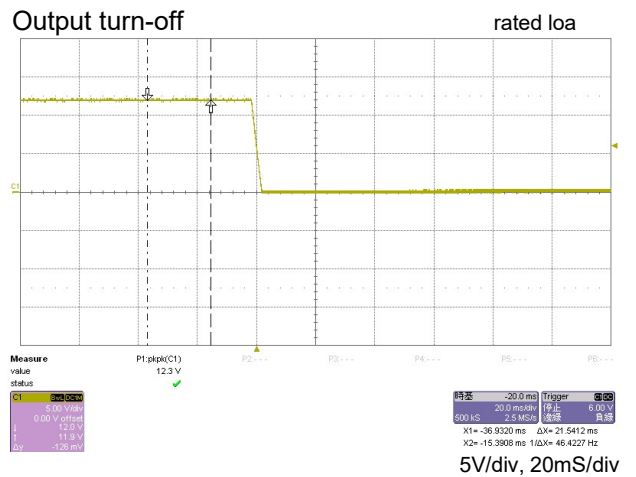
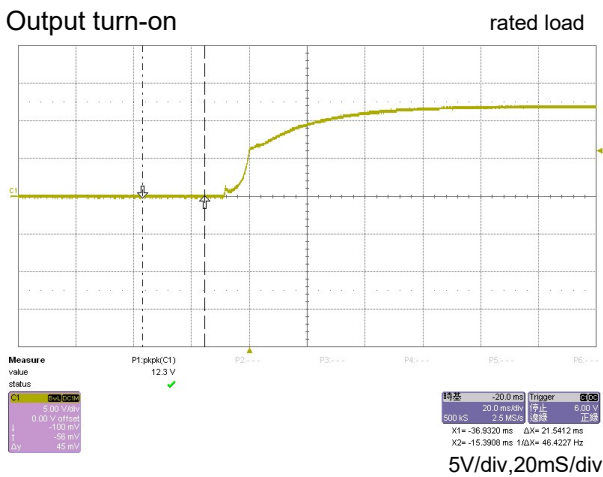
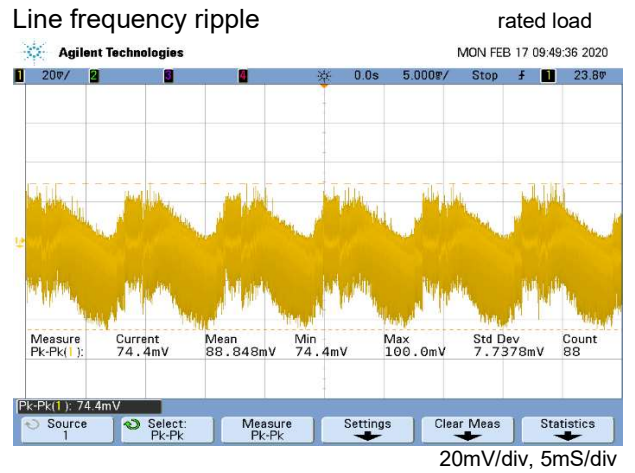
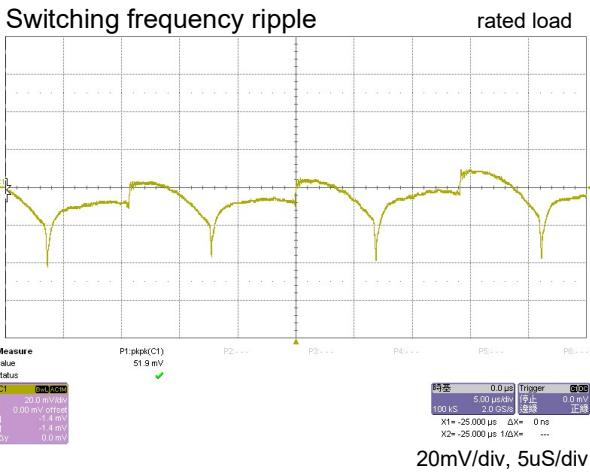

PG(Input voltage: 85Vac) rated load

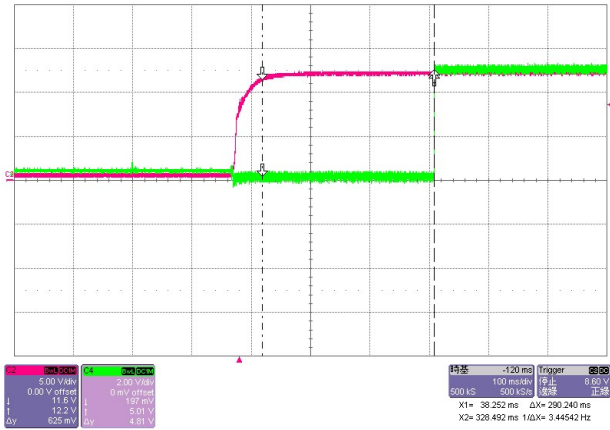

PF(Input voltage: 85Vac) rated load

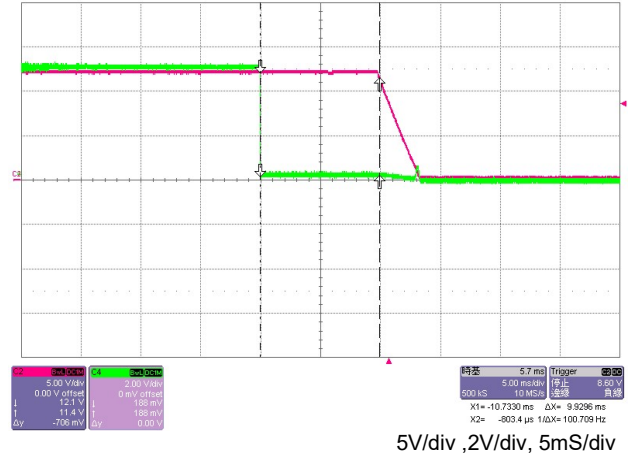

Step response

20%~100% of rated load

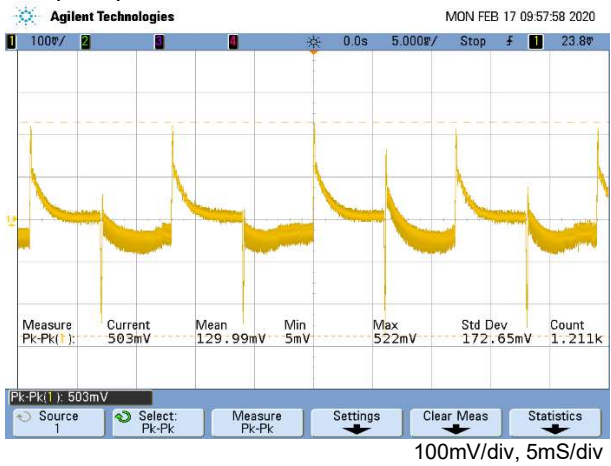

Remote on off

rated load

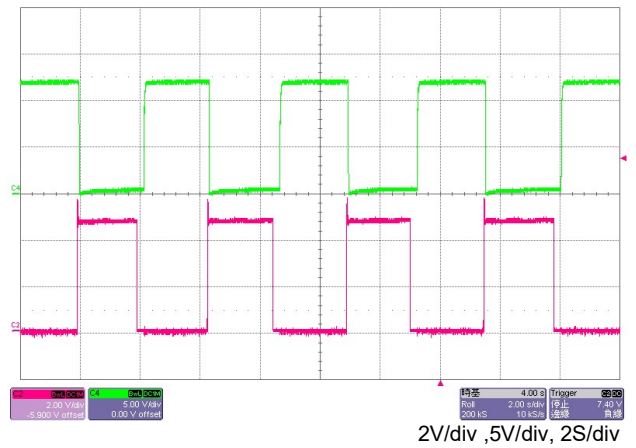

EMI: EN55011 "B" (Conduction)

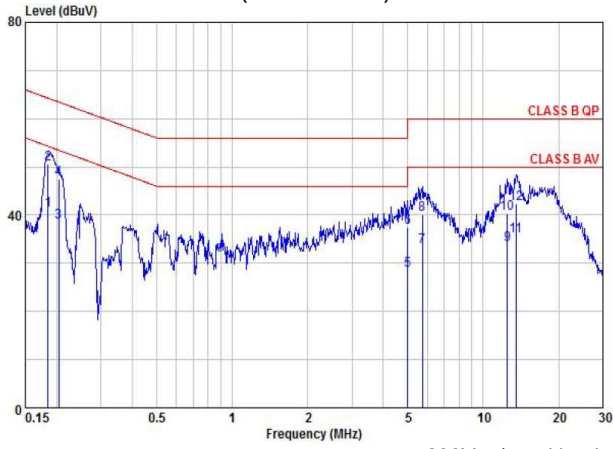

230Vac/rated load

EMI: FCC "B" (Conduction)

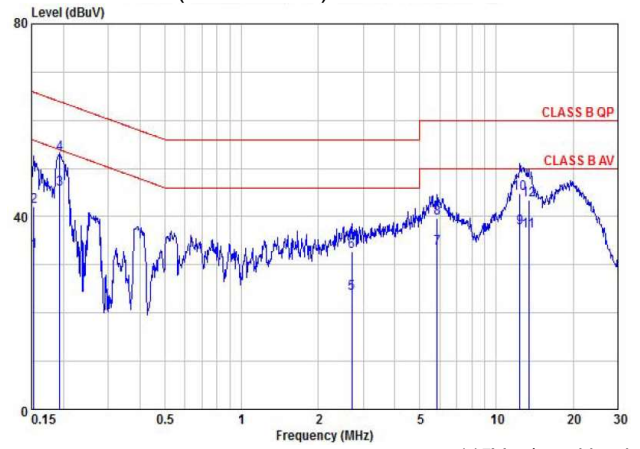

115Vac/rated load

EMI: EN55011 "B" (Radiation)

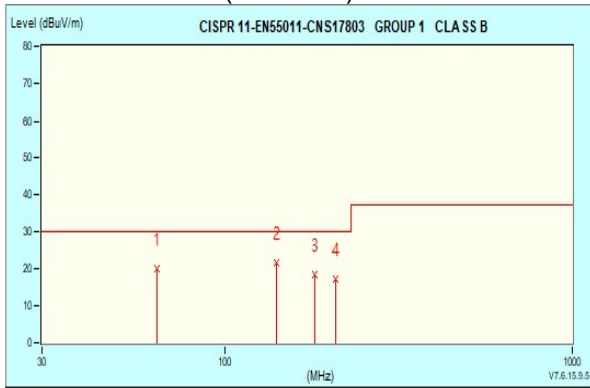

230Vac/rated load

EMI: FCC "B" (Radiation)

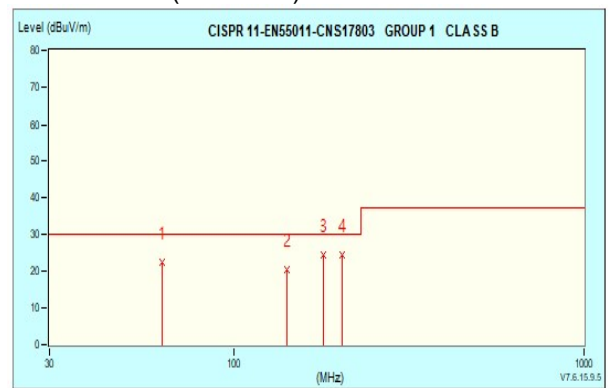

115Vac/rated load