

SPECIFICATION

For

SWITCHING POWER SUPPLY

M/N: MPE-S085(-SB)(-C)

MPE-S085(-SB)(-C)

80W AC / DC

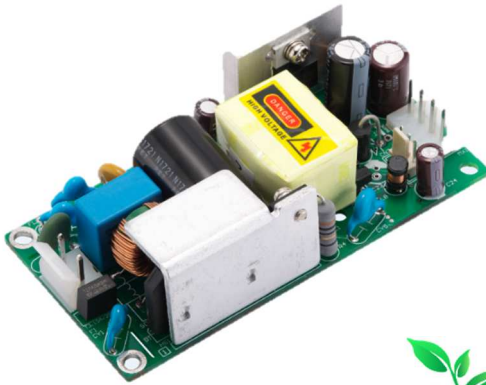

FEATURES

- ✓ 80W fan cooling, 65W with convection-cooled of single output power supply.
- ✓ Compact size 2 x 4 inch and low profile.
- ✓ No-load power consumption < 0.5W.
- ✓ Optional +5Vsb and remote on/off function.
- ✓ Operable at 80°C.
- ✓ Compliant with CLASS I & CLASS II meets EMI CISPR/FCC class B.
- ✓ ITE safety standard IEC62368-1, UL62368-1 approved.



Models & Ratings

Model Number	Wattage (Rated / Max)	Output Voltage		Min. Current	Rated Current	Max. Current
MPE-S085	65 W / 80 W	+24 V		0 A	2.7 A	3.3 A
MPE-S085-SB	65 W / 80 W	V1	+24 V	0 A	2.7 A	3.3 A
		V2	+5 V	0 A	0.1 A	0.5 A

The 65W rated load is natural convection cooling, maximum load 80W is at 50°C with 7 CFM fan convection cooling. please see the derating curve.

Model no. coding:

MPE-S085-X-Y-Z



1	X=	Output set
	blank	Single output
	SB	Dual output (with +5Vsb & remote on/off function)

2	Y=	Connector Type
	blank	Molex Type Connector or equivalent
	J	JST Type Connector or equivalent

3	Z=	Mechanical
	blank	Open frame
	C	Optional cover kit

Summary

Characteristic	Minimum	Typical	Maximum	Units	Notes & Conditions
Input Range	85	115 / 230	264	VAC	Continuous input range.
Input Frequency	47	50 / 60	63	Hz	AC input.
Efficiency	88	90		%	At input 230VAC, rated load, above 1hr. warm up.
Operation Temperature	-20		+80	°C	See the following performance curves for the detail.
Weight		85		g	-SB model is 86.5 g.
Dimensions	101.6 (L) x 50.8 (W) x 30 (H) mm, Tolerance +/- 0.4mm.				
EMC	EN 55032, CISPR 32 & FCC Part 15, EN 61000-3-2, EN 61000-3-3, EN 61204-3, IEC 61000-4-2, IEC 61000-4-3, IEC 61000-4-4, IEC 61000-4-5, IEC 61000-4-6, IEC 61000-4-8, IEC 61000-4-11				
Safety Approvals	IEC 62368-1, UL 62368-1, 2 nd Edition, CSA C22.2 No. 62368-1-14, 2 nd Edition IEC 60950-1, UL 60950-1, 2 nd Edition, CSA C22.2 No. 60950-1-07, 2 nd Edition				

Input

Characteristic	Minimum	Typical	Maximum	Units	Notes & Conditions
Input Voltage	85	115 / 230	264	VAC	Continuous input range.
Input Frequency	47	50 / 60	63	Hz	AC input.
Input Current			3	A	Nominal AC Input Voltage (115VAC), rated load.
Inrush Current			30 / 60	A	Nominal AC Input Voltage (115VAC/230VAC), one cycle at 25°C cold start.
No-load power consumption			<0.5	W	Nominal AC Input Voltage (115VAC/230VAC). Only with model MPE-S085.
Input Protection	One non-user serviceable internally located AC input line fuse. Fuse : 3.15A / 250VAC * 1pcs				

Output

Characteristic	Minimum	Typical	Maximum	Units	Notes & Conditions
Output Voltage		+24 V		DC	
		+5Vsb			
Output Current		2.7 ^(V1)	3.3	A	
		0.1 ^(V2)	0.5	A	
Initial Set Accuracy		±1.0 ^(V1) ±2.5 ^(V2)		%	Initial setting accuracy is adjusted at input 115VAC and output at 60% rated load.
Minimum Load		0		A	
Start Up Delay		0.5	1	Sec	Time required for initial output voltage stabilization.
Hold Up Time	16 / 80			mS	Nominal AC Input Voltage (115VAC/230VAC), rated load.
Line Regulation		±1.0 ^(V1) ±1.0 ^(V2)		%	Less than ±1% at rated load with ±10% changing in input voltage 115VAC.
Load Regulation		±1.0 ^(V1) ±1.0 ^(V2)		%	Measured from 60% to 100% rated load and from 60% to 20% rated load (60% ±40% rated load).
Ripple & Noise		150 ^(V1) 50 ^(V2)		mV	Measured at rated load and Nominal AC Input Voltage (115VAC/230VAC) by a 20MHz bandwidth limited oscilloscope and the each output is connected with a 10µF Electrolytic Capacitor and a 0.1µF Ceramic Capacitor.
Leakage Current			0.25	mA	At input 264VAC, 63Hz, rated load.
Overvoltage Protection	For some reason the power supply fails to control itself, the build-in over voltage protection circuit will auto recovery the outputs to prevent damaging external circuits, the trigger point is around 110%~135% of output voltage.				
Short Circuit Protection	Fully protected against output overload and short circuit. Automatic recovery upon of overload condition.				
Remote On / Off	The power supply will be turned on when the power On/Off pin is connected to secondary GND. This function exists only with optional +5Vsb.				

General

Characteristic	Minimum	Typical	Maximum	Units	Notes & Conditions
Efficiency	88	90		%	At input 230VAC, rated load, above 1hr. warm up.
Isolation	IP to OP	3000		VAC	
	IP to GND	1800		VAC	
Switching Frequency		65		KHZ	

Environmental

Characteristic	Minimum	Typical	Maximum	Units	Notes & Conditions
Operating Temperature	-20		+80	°C	See the following performance curves for the detail.
Storage Temperature	-40		+85	°C	
Relative Humidity	5		95	%RH	Non-condensing.
Cooling	7			CFM	Forced-cooled when 65W~80W.
Operating / Non-Operating Altitude		5000		m	

Note:

- 1.The temperature test is 100mm from the center of the top of the Power.
2. -20 °C low temperature start at 65W load

Derating curve

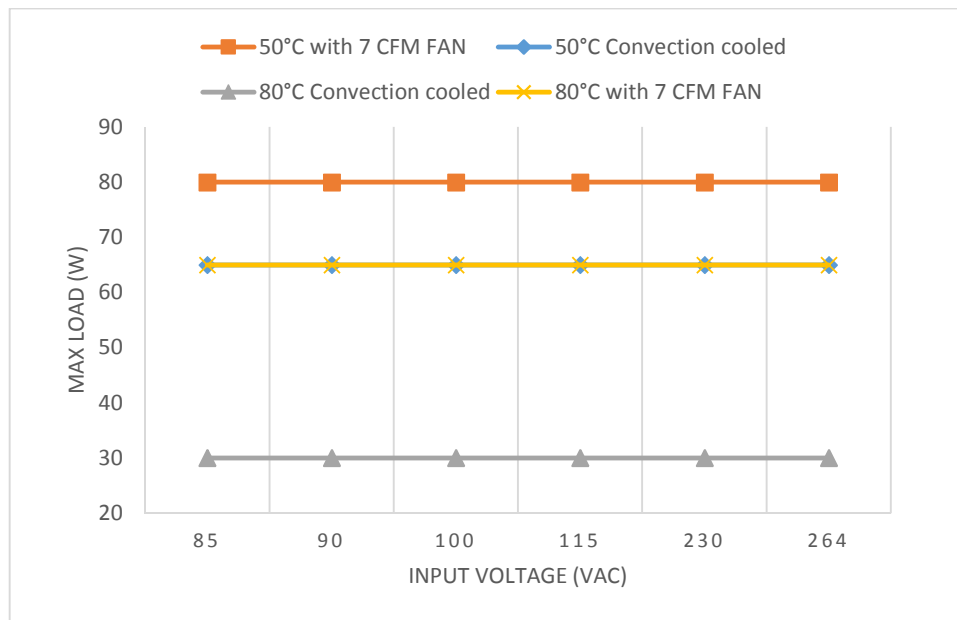

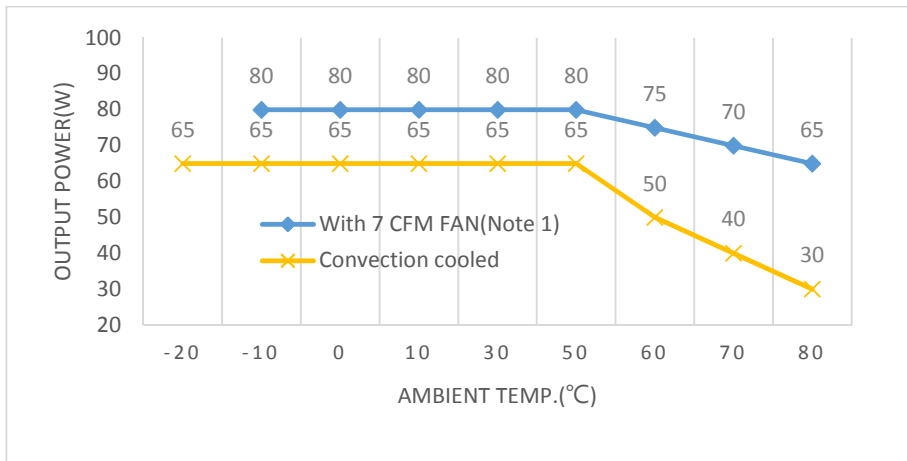

Note:

1. Air flow from IC3 to the body of PSU with distance 50mm maximum.

With optional cover (MPE-S085(-SB)-C)

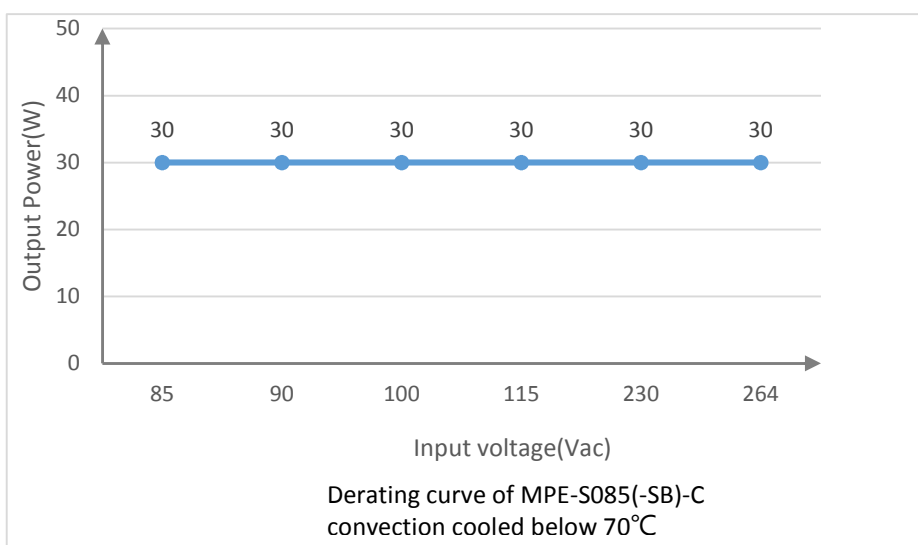
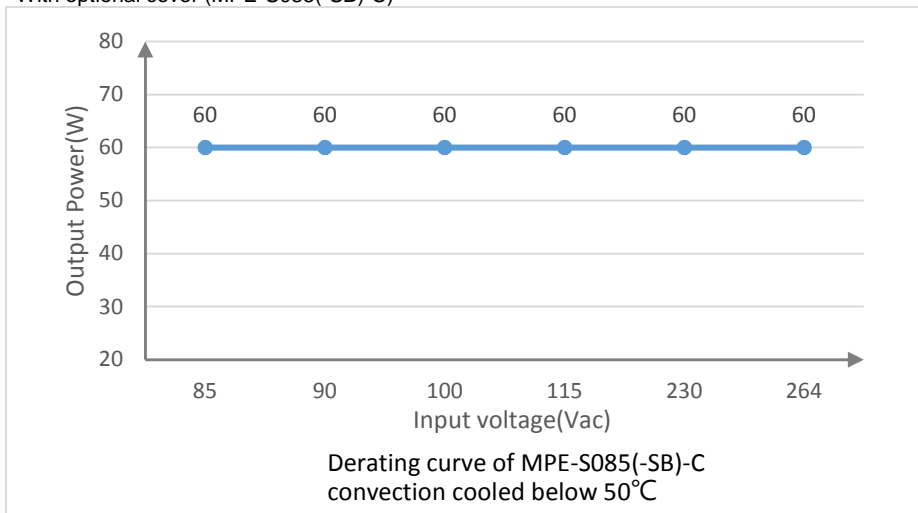

EMC: Emissions

Phenomenon	Standard	Class	Notes & Conditions
Conducted	EN 55032 CISPR 32 & FCC Part 15	B	Compliant with CLASS I & CLASS II EMI (Note 3.)
Radiated	EN 55032 CISPR 32 & FCC Part 15	B	
Harmonic Current	EN 61000-3-2	A	
Voltage Fluctuations	EN 61000-3-3		
Voltage Flicker	EN 61204-3	B	

EMC: Immunity

Phenomenon	Standard	Criteria	Notes & Conditions
ESD	IEC 61000-4-2	A	±8KV air discharge, ±6KV contact discharge
Radiated	IEC 61000-4-3	A	10V/m
EFT	IEC 61000-4-4	A	±2KV Line & PE
Surges	IEC 61000-4-5	A	L-N:±1KV, L/N-PE:±2KV
Conducted	IEC 61000-4-6	A	10V
Power Magnetic	IEC 61000-4-8	A	10A/m
Dips and Interruptions	IEC 61000-4-11	A A A / B B	DIP: >95%, 0.5 cycle DIP: 30%, 25 cycles DIP: 60%, 5 cycles (Note 2.) INT: >95%, 250 cycles

Note:

- As a build-in type power supply, the power supply needs to be installed in a suitable enclosure to pass the EMI/EMC tests. The final assembly has to comply with the valid EMI/EMC and safety.
- The test result of input 240Vac / 100Vac is criteria A / B.
- The Class I mounting holes should be connected to each other to conform the EMI limit ; Class II AC input radiation needs to be wound around the A81280200160 core 4 turns.
- Pass EMI with or without a metal plate below the power supply. If you want to use a metal plate under this power, the distance in between accessible metal part needs to add at least 6mm to meet Class II.

Safety Approvals

Safety Agency	Safety Standard	Notes & Conditions
TUV	EN 62368-1, 2 nd Edition(Design to meet)	CE(LVD) declaration.
	EN 60950-1, 2 nd Edition(Design to meet)	
CB	IEC 62368-1, 2 nd Edition	
	IEC 60950-1, 2 nd Edition	
UL/cUL	UL 62368-1, 2 nd Edition, CSA C22.2 No. 62368-1-14, 2nd Edition	UL, cUL approved.
	UL 60950-1, 2 nd Edition, CSA C22.2 No. 60950-1-07, 2nd Edition	

MPE-S085(-SB)(-C)

80W AC / DC

Mechanical Details

M/N: MPE-S085-SB

Unit: mm

SIZE : 101.6(L) x 50.8(W) x 30(H)mm, Tolerance +/-0.4mm.

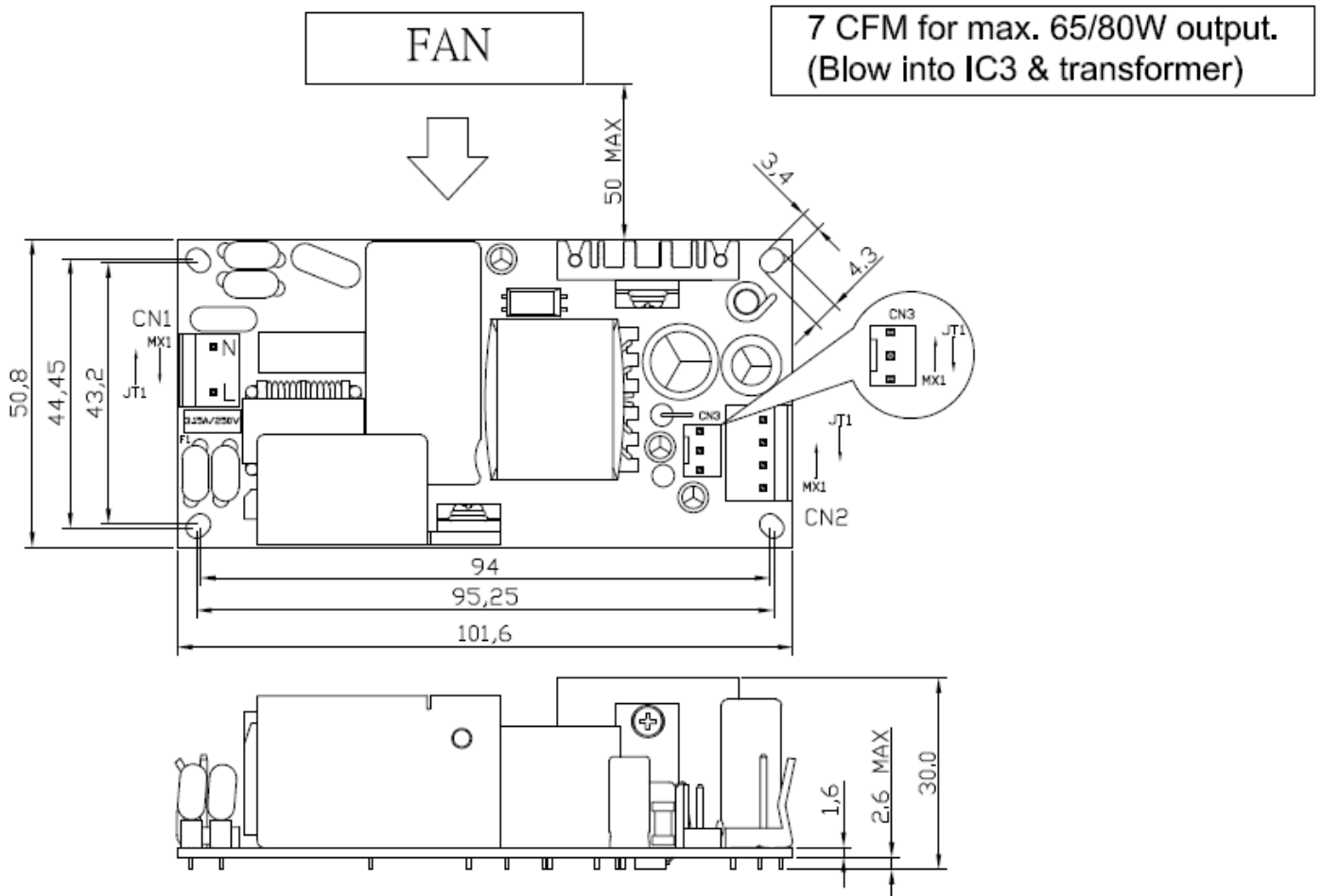

Note: The installation shall be kept in an isolation distance min. 2.8mm between the unit and the system chassis. There exist hazardous voltage in dotted area, keep insulating to avoid hazardous electric shock.

MPE-S085(-SB)(-C)

80W AC / DC

For m/n: MPE-S085(-SB)-C
Unit: mm Tolerance: +/- 0.4mm

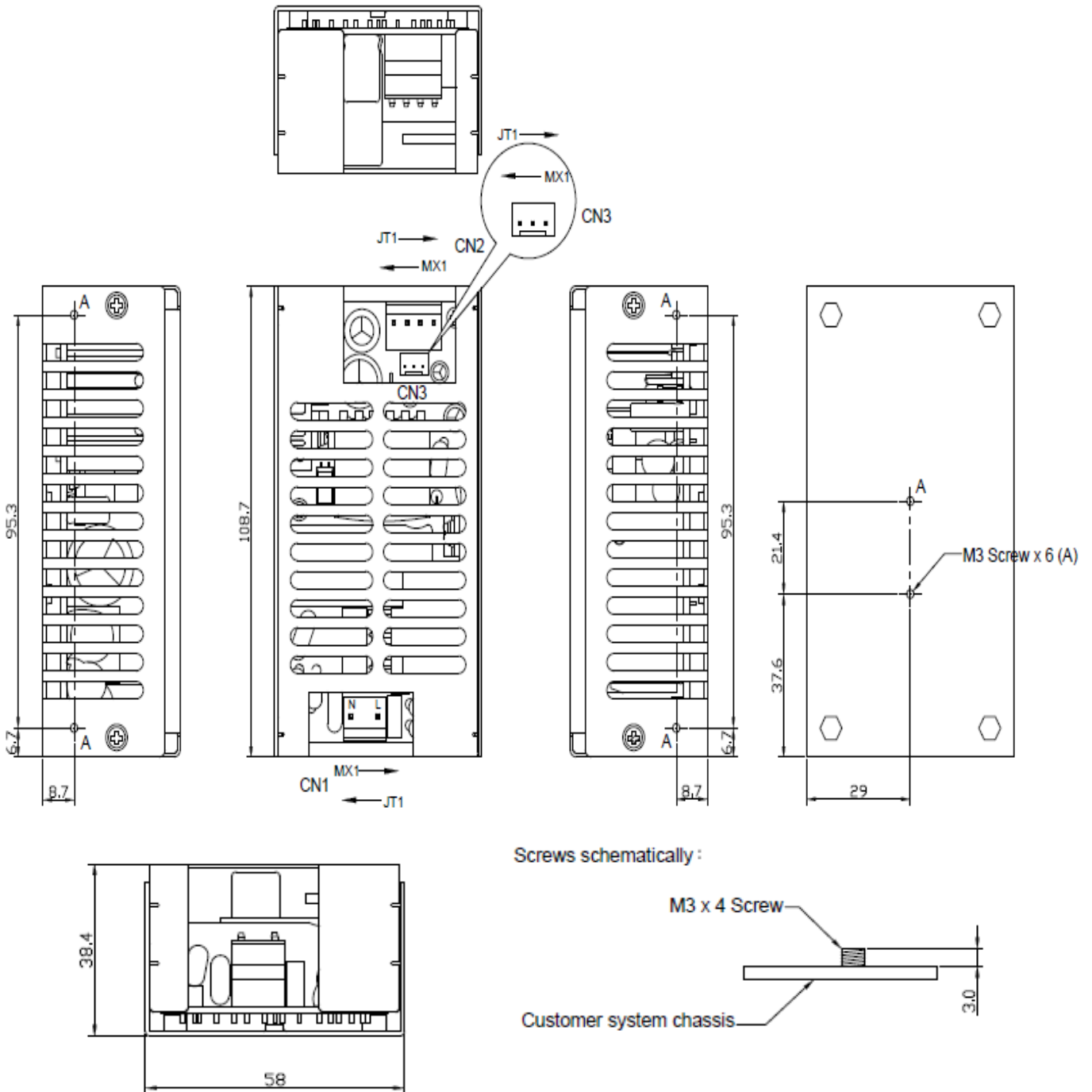

Parameter	Conditions/Description					
Dimension	101.6 (L) x 50.8 (W) x 30 (H) mm, Tolerance +/- 0.4mm.					
Connector & Pin Assignment	Location	Pin (Note 1)		Assignment	Proposed Housing	Proposed Terminals
	CN1(Input) molex 09-65-2038 or equivalent (remove the middle pin)	MX1	JT2	AC in (N)	a. MOLEX: 09-50-1031 (5195-03) or 09-52-4034 (5239-03) or equivalent	a. MOLEX :5194 or 5225 2478, 2578,5167 or 5168 or equivalent
		MX2	JT1	AC in (L)	b. JST: VHR-3N or equivalent (Note 2)	b. JST: SVH-21T-P1.1 or equivalent
	CN2(Output) molex 09-65-2048 or equivalent	MX1	JT4	0 V	a. MOLEX: 09-50-1041 (5195-04) or 09-52-4044 (5239-04) or equivalent	a. MOLEX:5194 or 5225 2478, 2578,5167 or 5168 or equivalent
		MX2	JT3	0 V		
		MX3	JT2	+ V	b. JST: VHR-4N or equivalent (Note 2)	b. JST: SVH-21T-P1.1 or equivalent
		MX4	JT1	+ V		
	CN3(Note 3) molex 22-04-1031 or equivalent	MX1	JT3	+5Vsb	a. MOLEX: 22-01-1032 (5051-03) or 51191-0300 or equivalent	a. MOLEX:2759 or 5159 or 50802 or equivalent b. JST: SXH-001T-P0.6N, SXH-001T-P0.6 or SXH-002T-P0.6 or equivalent
		MX2	JT2	0 V		
		MX3	JT1	RC	b. JST: XHP-3 or equivalent (Note 2)	

Note:1. The pin assignment "MX" for Molex type connector or equivalent, "JT" for JST type connector.

2. Exist with model no. suffixed -J, please see the Model no. coding.
3. Exist with model no. suffixed -SB, please see the Model no. coding.

Thermal Considerations

In order to ensure safe operation of the PSU in the end-use equipment, the temperature of the components listed in the table below must not be exceeded.

Temperature should be monitored using J type thermocouples placed on the hottest part of the component (out of any direct air flow). See Mechanical Details for component locations.

Temperature Measurements at max. amb.	
Component	Max Temperature
T1	110°C
Q1	130°C
D6	130°C
C2	105°C
C21	105°C

Performance

(Input voltage: 115Vac)

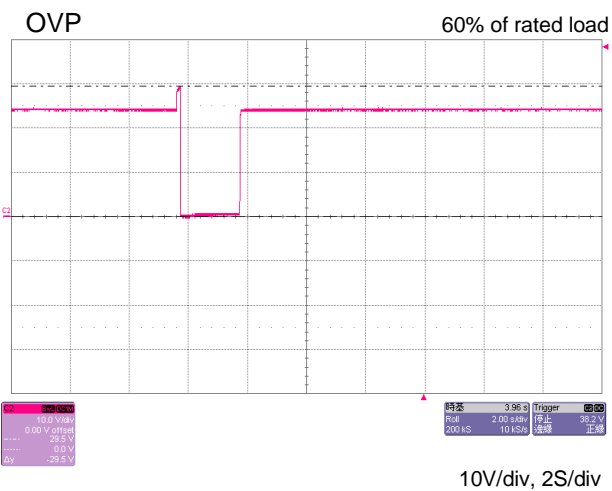
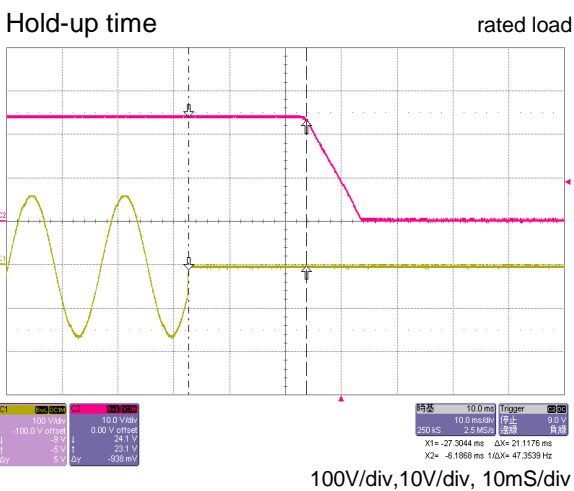
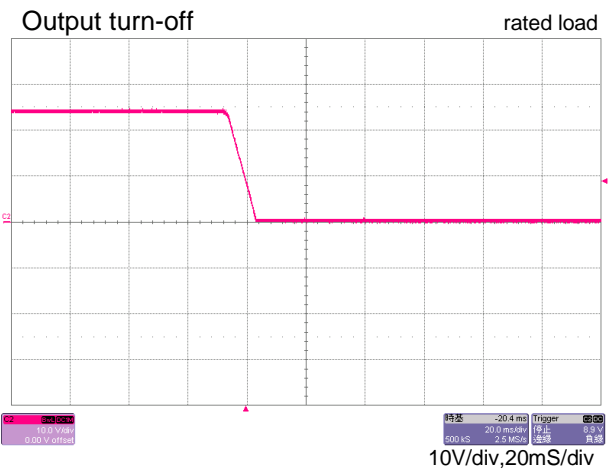
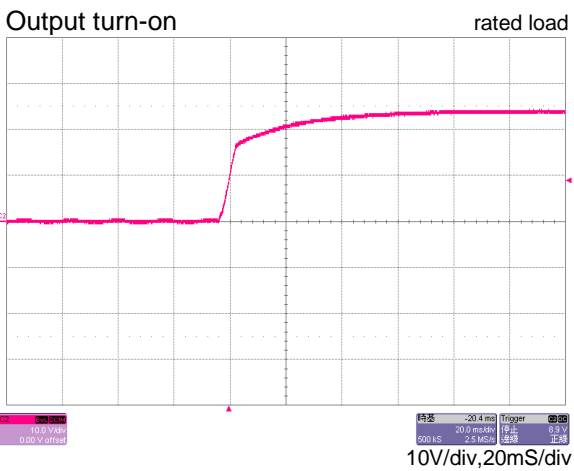
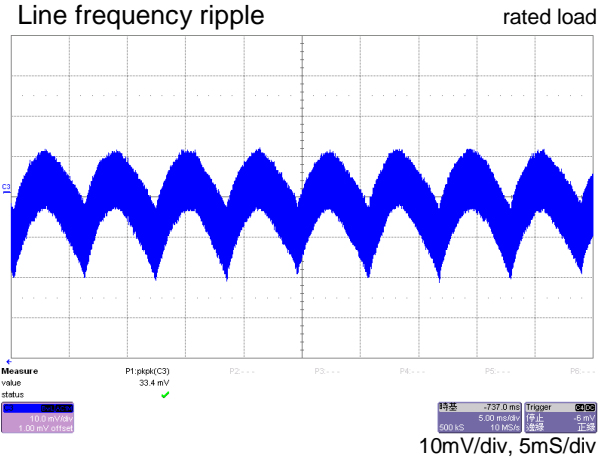
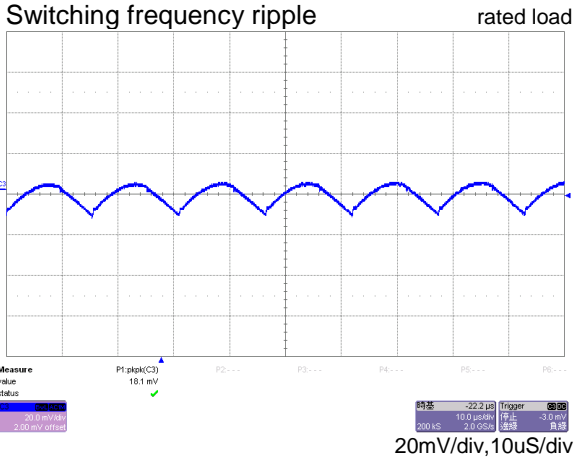

Step response 20%~100% of rated load

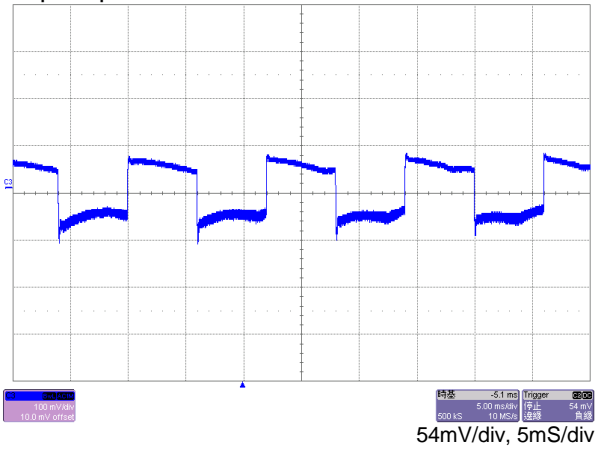

EMI: EN55032 "B" (Conduction)

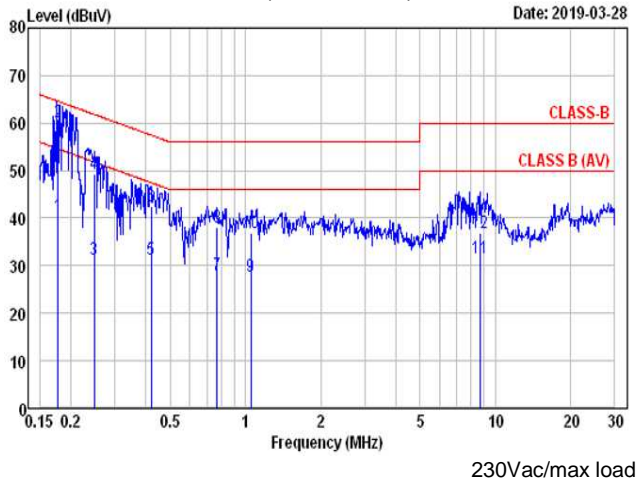

EMI: FCC "B" (Conduction)

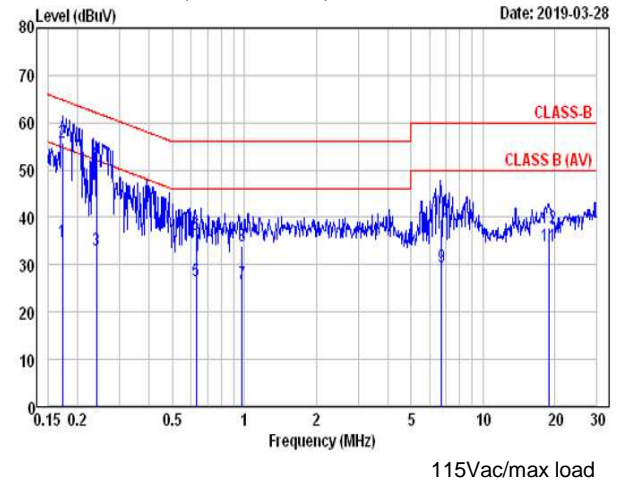

EMI: EN55032 "B" (Radiation)

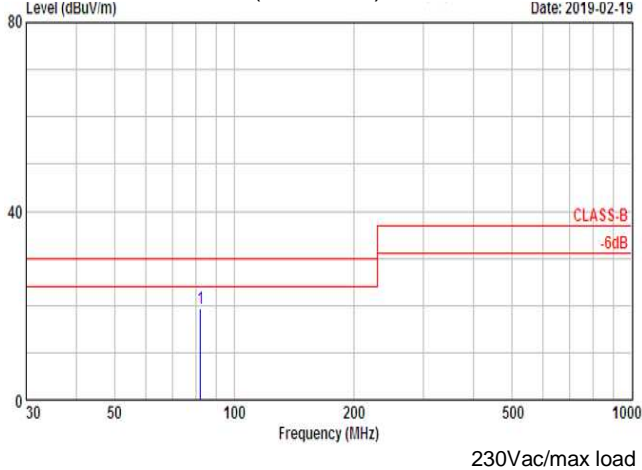

EMI: FCC "B" (Radiation)

