

**SPECIFICATION**

**For**

**SWITCHING POWER SUPPLY**

**M/N: MPE-J025(-T) (24V / 1.04A)**



# MPE-J025

24V / 1.04A AC / DC



## FEATURES

- ✓ 25W convection-cooled @ 50°C ambient.
- ✓ Wide operating temperature -30~80°C.
- ✓ Compact size 2" x 2.5" with low profile 24.6mm.
- ✓ No-load power consumption < 0.3W.
- ✓ Class II & class I with functional ground connected.
- ✓ Safety Approval ITE standard IEC, EN, 62368-1, 2nd Edition LVD approved.
- ✓ Meet EMI CISPR 32 / FCC Part 15 class B.



## Models & Ratings

Model Number	Wattage (Rated)	Output Voltage	Min. Current	Rated Current
MPE-J025	25 W	+24 V	0 A	1.04 A

Total Output Power: Max. 25W with convection cooled at 50°C environment temperature.

1. Model no. coding:

## MPE-J02X-Y

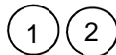

X=	Output (V)
2	+5
3	+12
5	+24
6	+48



Y=	Input / Output Connector Type	
blank	Standard JST Type Connector or equivalent	
T	PCB Mount Type (Soldered Pins)	

## Summary

Characteristic	Minimum	Typical	Maximum	Units	Notes & Conditions
Input Range	85	115 / 230	264	VAC	Continuous input range.
Input Frequency	47	50 / 60	63	Hz	AC input.
Efficiency		85 / 86		%	Nominal AC Input Voltage(115/230VAC).
Operation Temperature	-30		+80	°C	Please refer to the performance curves as following.
Weight		64		g	
Dimensions	63.5 (L) x 50.8 (W) x 24.6 (H) mm, Tolerance +/- 0.5mm				
EMC	EN 55032, CISPR 32 & FCC Part 15, EN 61000-3-2, EN 61000-3-3 IEC 61000-4-2, IEC 61000-4-3, IEC 61000-4-4, IEC 61000-4-5, IEC 61000-4-6, IEC 61000-4-8, IEC 61000-4-11				
Safety Approvals	IEC 62368-1:2014 (Second Edition), designed to meet. EN 62368-1:2014 + A11: 2017 LVD Report				

## Input

Characteristic	Minimum	Typical	Maximum	Units	Notes & Conditions
Input Voltage	85	115 / 230	264	VAC	Universal input range.
Input Frequency	47	50 / 60	63	Hz	AC input.
Input Current			0.6 / 0.35	A	Nominal AC Input Voltage (115VAC/230VAC), rated load.
Inrush Current			30 / 60	A	Nominal AC Input Voltage (115VAC/230VAC), one cycle at 25°C cold start.
Earth Leakage Current			0.25	mA	
No-load power consumption			0.3	W	
Input Protection	One non-user serviceable internally located AC input line fuse. Fuse : 2A / 250VAC * 1pcs				

## Output

Characteristic	Minimum	Typical	Maximum	Units	Notes & Conditions
Output Voltage		24		VDC	
Output current		1.04		A	
Initial Set Accuracy		±2		%	Initial setting accuracy is at Input 115VAC and output at 60% rated load.
Minimum Load		0		A	
Start Up Delay		2.2	3.5	Sec	Time required for initial output voltage stabilization.
Hold Up Time		16 / 75		mS	Nominal AC Input Voltage (115VAC/230VAC),rated load.
Line Regulation		±0.5		%	Less than ±1% at rated load with ±10% changing in input voltage 115VAC.
Load Regulation		±0.5		%	Measured from 60% to 100% rated load and from 60% to 20% rated load (60% ±40% rated load).
Ripple & Noise		120		mV	Measured at rated load and Nominal AC Input Voltage (115VAC/230VAC) by a 20MHz bandwidth limited oscilloscope and the each output is connected with a 10µF Electrolytic Capacitor and a 0.1µF Ceramic Capacitor.
Overvoltage Protection	The build-in over voltage protection circuit will auto recovery the outputs to prevent damaging external circuits, the trigger point is around 110%~140% of output voltage.				
Overload Protection	Automatic recovery.				
Short Circuit Protection	Fully protected against output short circuit. Automatic recovery.				

## General

Characteristic	Minimum	Typical	Maximum	Units	Notes & Conditions
Efficiency		85 / 86		%	Nominal AC Input Voltage(115/230VAC).
Isolation	IP to OP	3000		VAC	
	IP to GND	1800		VAC	
Switching Frequency		65		KHZ	

## Environmental

Characteristic	Minimum	Typical	Maximum	Units	Notes & Conditions
Operating Temperature	-30		+80	°C	Please refer to the derating curves. In order to stabilize spec., need to warm up at negative temperature.
Storage Temperature	-40		+85	°C	
Relative Humidity	5		95	%RH	Non-condensing.
Operating Altitude		5000		m	
Vibration	0.26		6.09	G	Frequency Type: Sweep Frequency Frequency Range: 10~55 Hz Displacement: 1.0mm Sweep Rate: 60 minute / cycle Number of cycle: 1 cycle / axis Direction: X ,Y and Z axis

## Derating curve

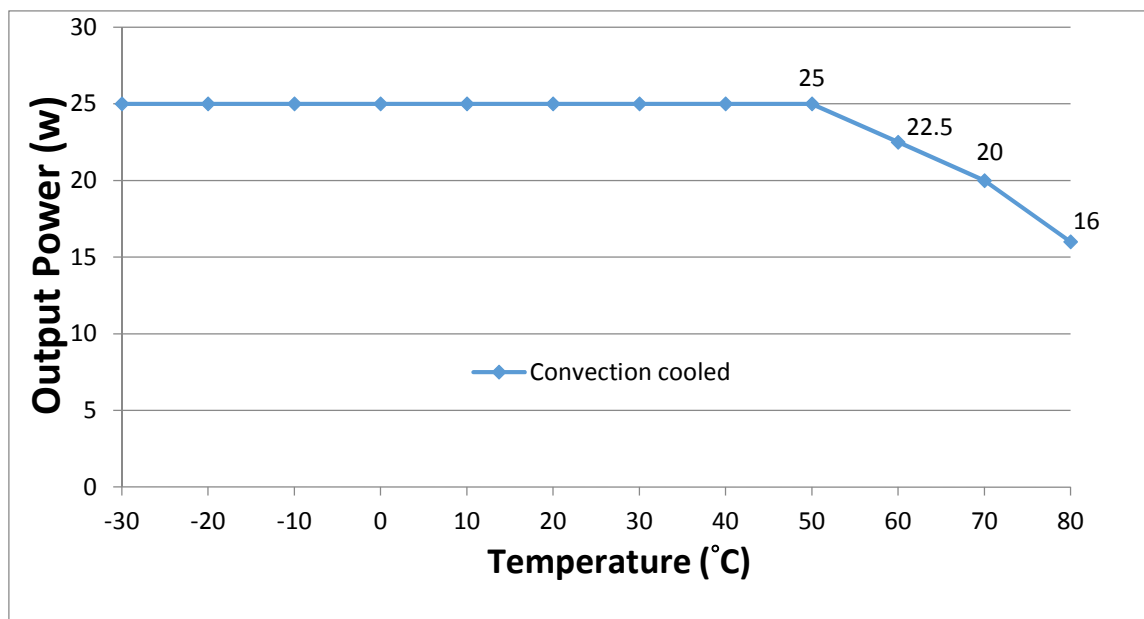

## EMC: Emissions

Phenomenon	Standard	Class	Notes & Conditions
Conducted	EN 55032, CISPR 32 & FCC Part 15	B	
Radiated	EN 55032, CISPR 32 & FCC Part 15	B	
Harmonic Current	EN 61000-3-2	A	
Voltage Flicker	EN 61000-3-3	Pass	

## EMC: Immunity

Phenomenon	Standard	Criteria	Notes & Conditions
ESD	IEC 61000-4-2	A	±8KV air discharge, ±6KV contact discharge
Radiated	IEC 61000-4-3	A	10V/m
EFT	IEC 61000-4-4	A	±2KV Line & PE
Surges	IEC 61000-4-5	A	L-N:±1KV, L/N-PE:±2KV
Conducted	IEC 61000-4-6	A	10V
Power Magnetic	IEC 61000-4-8	A	10A/m
Dips and Interruptions	IEC 61000-4-11	A / B A / B A / B B	DIP: >95%, 0.5 cycle <sup>(Note 1)</sup> DIP: 30%, 25 cycles <sup>(Note 1)</sup> DIP: 60%, 5 cycles <sup>(Note 1)</sup> INT: >95%, 250 cycles

Note:

1. The test result of input 240Vac / 100Vac is criteria A / B.

## Safety Approvals

Safety Agency	Safety Standard	Notes & Conditions
CB	IEC 62368-1:2014 (Second Edition)	Designed to meet.
CE	EN 62368-1:2014 + A11: 2017	LVD report.
UL/cUL	UL 62368-1, 2nd Edition, CSA C22.2 No. 62368-1-14, 2nd Edition	Designed to meet.

## Mechanical Details

Unit: mm  
 MPE-J025  
 SIZE : 63.5(L) x 50.8(W) x 24.6(H)mm, Tolerance +/-0.5mm

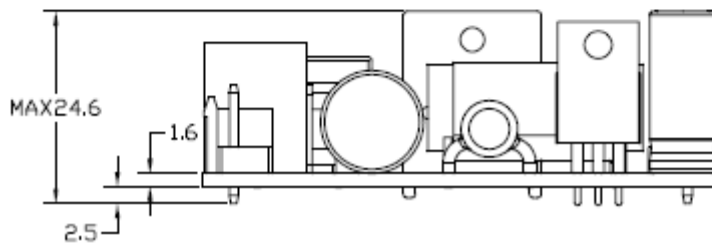
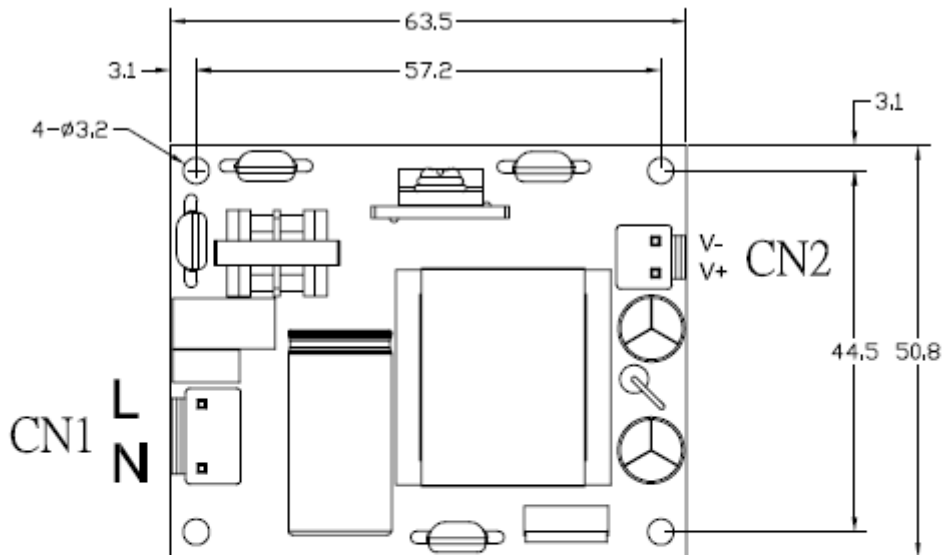

Parameter	Conditions/Description				
Dimension	63.5 (L) x 50.8 (W) x 24.6 (H) mm, Tolerance +/- 0.5mm.				
Connector & Pin Assignment	Location	Pin	Assignment	Proposed Housing	Proposed Terminals
	CN1 (Input)	JT 3	AC in (N)	JST: VHR-3N or equivalent	JST: SVH-21T-P1.1 or equivalent
		JT 2	N / A		
		JT 1	AC in (L)		
	CN2 (Output)	JT 2	0 V	JST: VHR-2N or equivalent	JST: SVH-21T-P1.1 or equivalent
JT 1		+ V			

# MPE-J025

24V / 1.04A AC / DC

PCB Mount Type

SIZE : 63.5(L) x 50.8(W) x 26.4(H)mm, Tolerance +/-0.5mm

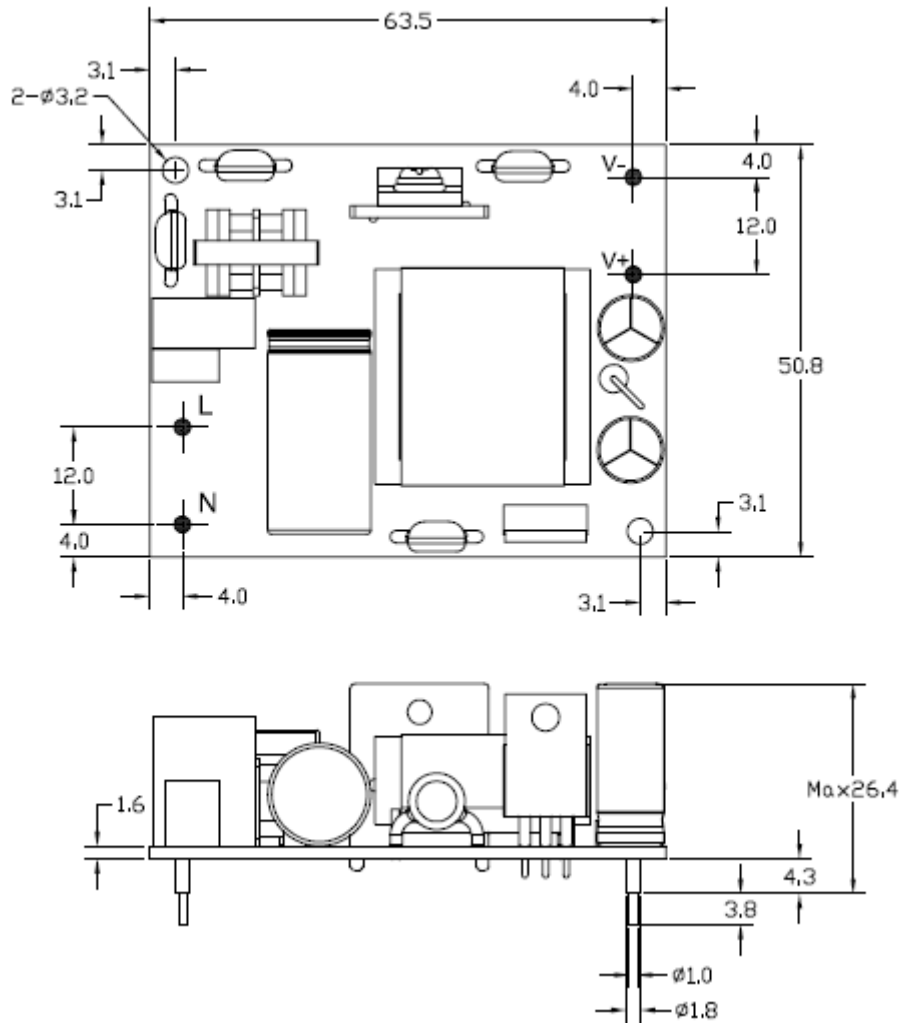

## Thermal Considerations

In order to ensure safe operation of the PSU in the end-use equipment, the temperature of the components listed in the table below must not be exceeded.

Temperature should be monitored using J type thermocouples placed on the hottest part of the component (out of any direct air flow). See Mechanical Details for component locations.

Temperature Measurements at max. amb.

Component	Max Temperature
T1	110°C
Q1	120°C
D5	120°C
C2	105°C
C9	105°C



### Performance

(Input voltage: 115Vac)

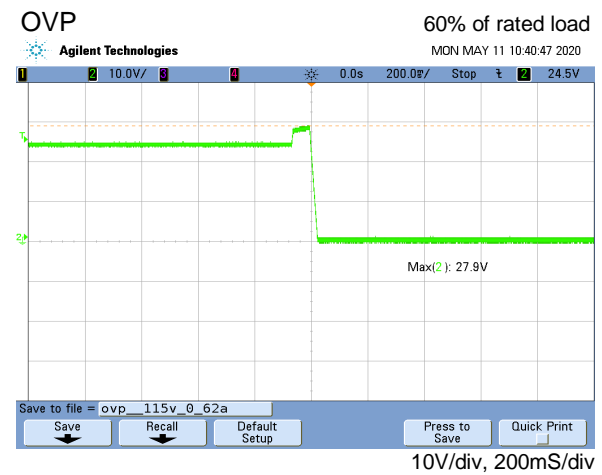
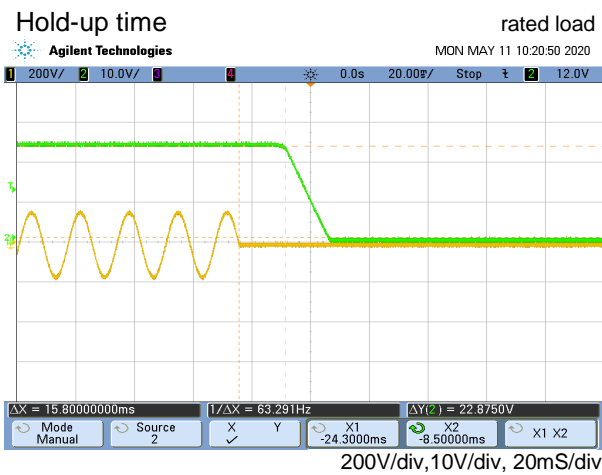
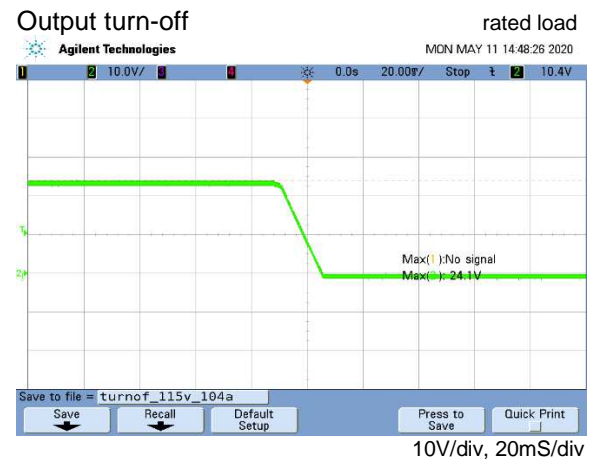
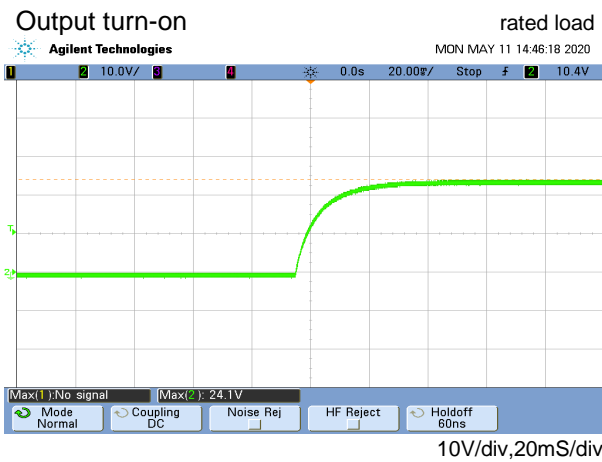
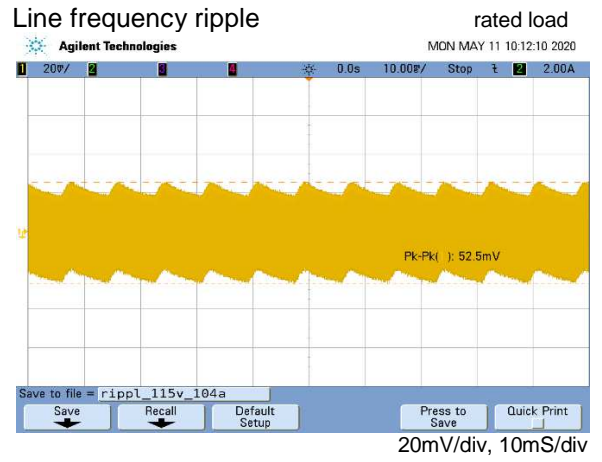
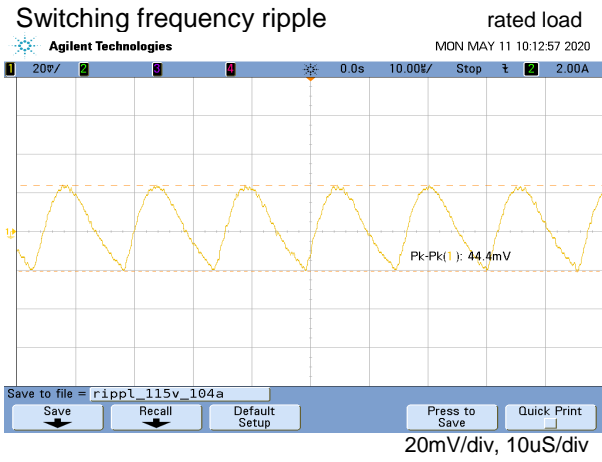

## Step response

20%~100% of rated load



## EMI: EN 55032 "B" (Conduction)

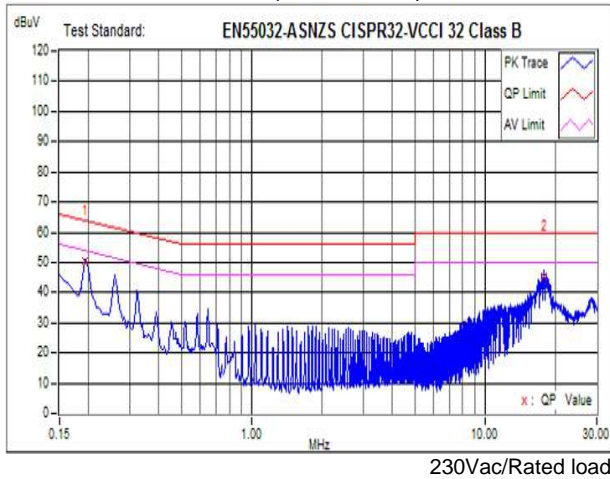

230Vac/Rated load

## EMI: FCC "B" (Conduction)

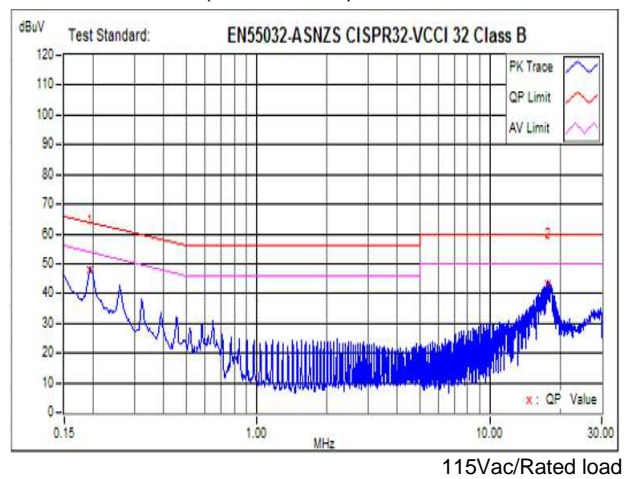

115Vac/Rated load

## EMI: EN 55032 "B" (Radiation)

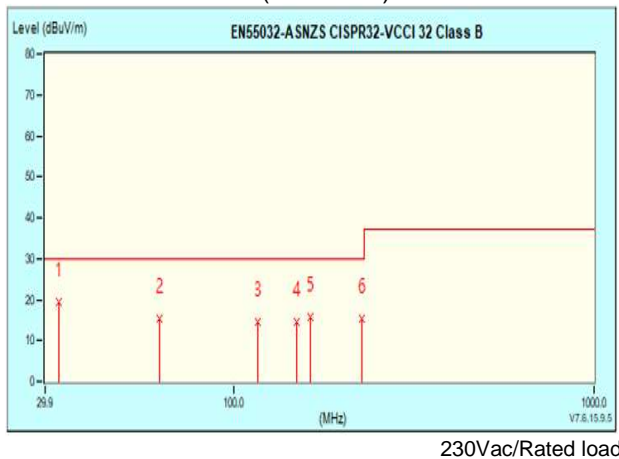

230Vac/Rated load

## EMI: FCC "B" (Radiation)

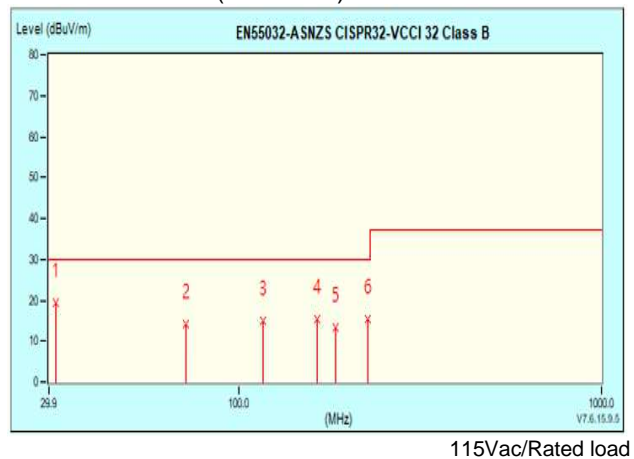

115Vac/Rated load